



Don-Jo Wall Bumpers

1400

1" Diameter

With Anchor Screw - Cast Brass



Stocked Product

1400 - 613, 626
1406 - 625
1407 - 619

1406

2 1/2" Diameter

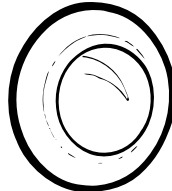

Plastic Anchor & Plastic Dry Wall Anchor
Wrought Material

1407

2 1/2" Diameter

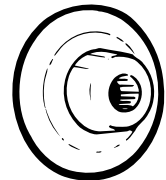

Floor Stops

1440

Low Style

1/8" H x 1 3/4" Diameter Base

W/S & MS & Exp Shield & Plastic Anchor

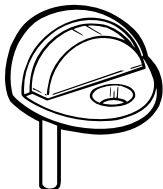

Stocked Product

1440 - 619
1442 - 619

1442

High Style

3/8" H x 1 3/4" Diameter Base

W/S & MS & Exp Shield & Plastic Anchor

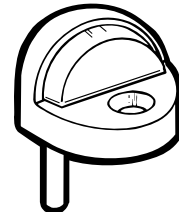

Door Holder

1467

5" Projection

Solid Brass Material

SMS Fastener

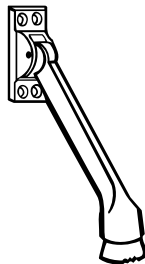

Stocked Product

1467 - 605, 613, 626



Don-Jo

Push & Pull Plates, Pull Handles

35 Door Pull

5 1/2" CTC

• Dimensions - Overall x Projection x Clearance

7 1/2" x 1 7/8" x 1 1/2"

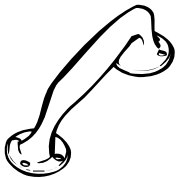

Stocked Product

- 35 - 630
- 70 - 605
- 71 - 605, 613, 629, 630
- 7015 - 605, 613, 630
- 7115 - 605, 629

70,71 Push Plate

70 - 3 1/2" x 15"

71 - 4" x 16"

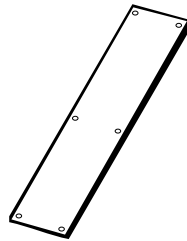

7015, 7115 Pull Plate

7015 - 3 1/2" x 15"

7115 - 4" x 16"

6" CTC

3/4" diameter pull

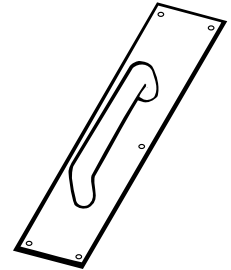

Strikes

9234

2 3/4" x 1 1/8"

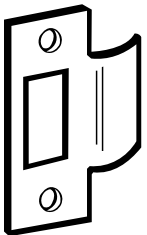

ST161

4 7/8" x 1 1/4"

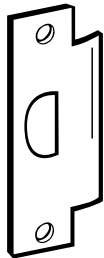

ST214

2 1/4" x 1 1/4"

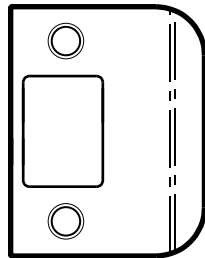

Stocked Product

- 9234 - 605, 630
- ST161 - 605, 613, 626
- ST214 - 605, 630

2-SDS

4 7/8" x 1 1/4"



TS-100-CP Thimble strike

1" Diameter



Stocked Product

- 2-SDS-BP (Steel Brass Plated)
- 2-SDS-SL (Steel Silver Coated)
- TS-100-CP (Chrome Plated)



Don-Jo - *Extended Lip Strikes*

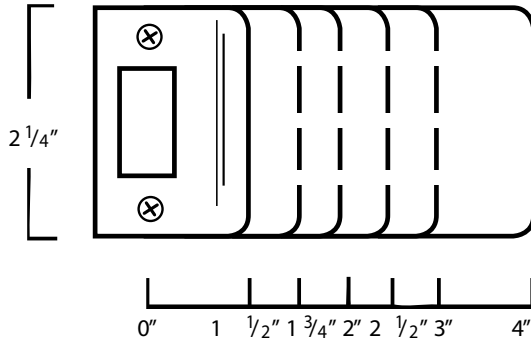

2-1/4" Extended Lip Strike

Number	Dimension
EL102	2-1/4" X 2"
EL115	2-1/4" X 1-1/2"
EL125	2-1/4" X 2-1/2"
EL175	2-1/4" X 1-3/4"

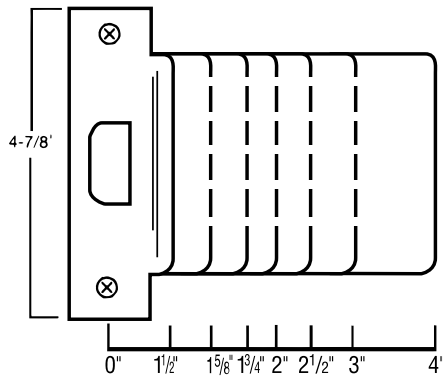

4-7/8" Extended Lip ANSI Strike

Number	Dimension
EST102	4-7/8" X 2"
EST115	4-7/8" X 1-1/2"
EST125	4-7/8" X 2-1/2"
EST158	4-7/8" X 1-5/8"
EST175	4-7/8" X 1-3/4"

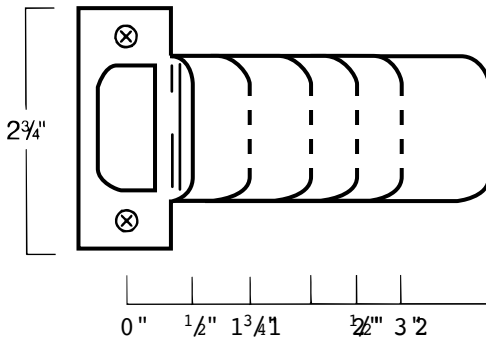

2-3/4" Extended Lip T-Strike

Number	Dimension
ETS102	2-3/4" X 2"
ETS115	2-3/4" X 1-1/2"
ETS125	2-3/4" X 2-1/2"
ETS175	2-3/4" X 1-3/4"

Stocked Product

2-1/4" Extended Lip Strike

EL102 - DU, 605, 619, 630
 EL115 - DU, 605, 619, 630
 EL125 - DU, 630
 EL175 - DU, 605, 619, 630

4-7/8" Extended Lip ANSI Strike

EST102 - 630
 EST115 - 630
 EST125 - 630
 EST158 - 630
 EST175 - 630

2-3/4" Extended Lip T-Strike

ETS102 - 630
 ETS115 - 630
 ETS125 - 630
 ETS175 - 630



Don-Jo - Architectural Accessories

AR335630

Use with levers on 1 3/8" door
(2 per pack)
3-1/2" Diameter
Finish - 630

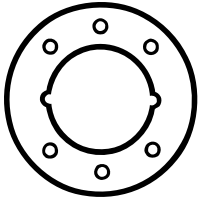

BF161SL

Covers up to 2 1/8" Hole
2-5/8" Diameter
Finish - Silver Coated

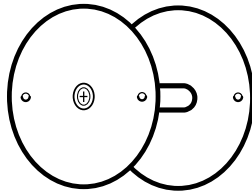

BF178SL

Covers up to 1 1/2" Hole
1-7/8" Diameter
Finish - Silver Coated

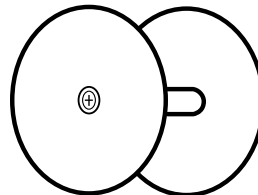

CV86PC

Converts 86
Cut out to 161
8" x 1-1/4"
Finish - Prime Coated



DSP135630

Scar Plate
Fits under Deadbolt
Collars 3-1/2" OD, 1-1/2" ID
Finish 630

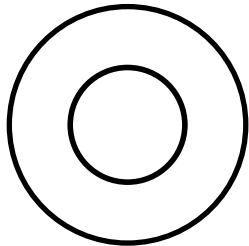

EF86PC

86 cut out
8" x 1 1/4" x 3/16"
Finish - Prime Coated

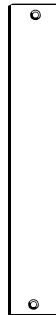

EF161

Filler Plate
2-1/4" x 1-1/8"

EF161SPC

Filler Plate
2-3/4" x 1-1/8"

Cut out
Finish - Prime Coated

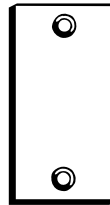

FF45PC

Frame hinge cut out
4-1/2" x 1-5/8"
Finish - Prime Coated

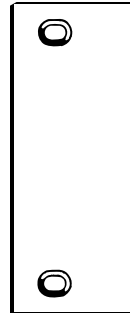

FS260PC

ANST strike cut out
Finish - Prime Coated
4-7/8" X 1-1/4"

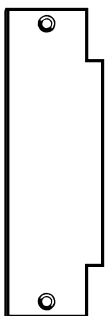

HF45PC

Door hinge cut out
4-1/2" x 1-3/4"
Finish - Prime Coated

SHF45PC

4-1/2" x 1-1/2"
Finish - Prime Coated

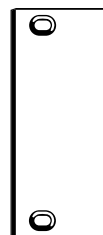

HS060

16 (.060) Gauge Hinge shime

HS090

13 (.090) Gauge Hinge shime
Finish - Prime Coated

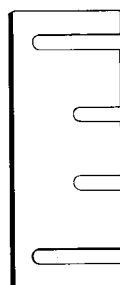

SP135630

Scar Plate
Fits under Rose or
Key in knob or Deadbolt
3-1/2" OD, 2-1/8" ID
Finish 630

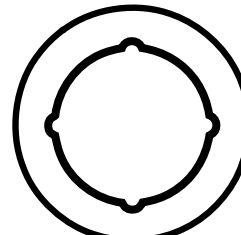

TB215

TAB
Finish - Zinc Plated
1" X 1-1/2"

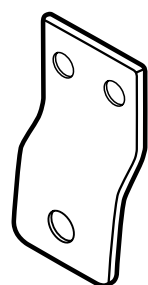



Don-Jo - Remodel Plates

RP-13509

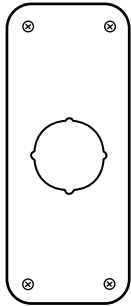

RP-13509-2

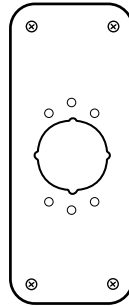

RP-13515

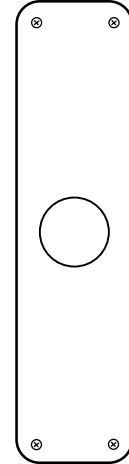

RPK-109

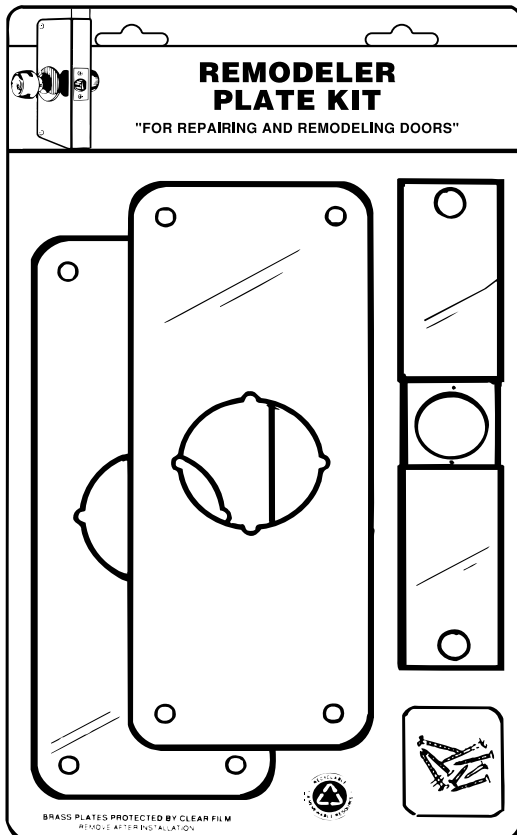

RP-13545

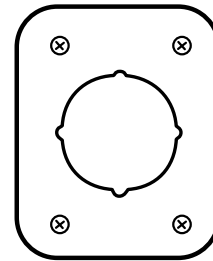

Stocked Product

Item	Size	Finishes
RP-13509	3-1/2" x 9"	630 (stainless)
RP-13509-2	3-1/2" x 9"	630 (stainless)
RP-13515	3-1/2" x 15"	630 (stainless)
RP-13545	3-1/2" x 4-1/2"	630 (stainless)
RPK-109	3-1/2" x 9"	605 (polished brass) 630 (stainless steel)



Don-Jo Lock Guard Plates

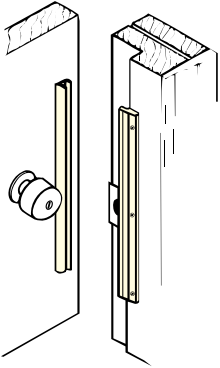

ILP206 / ILP212

The INTERLOCK for inswinging doors

- 6" version for use with key-in-knob and deadbolt locks
- 12" version for use with Mortise Locks, Simplex 1000 series, Alarm Lock DL-2500, DL-2700 & 3000, Card Access Systems, etc.

Stocked Product

ILP206 6"
ILP212 12"

Finishes:
DU (Duro Coated)
SL (Silver Coated)

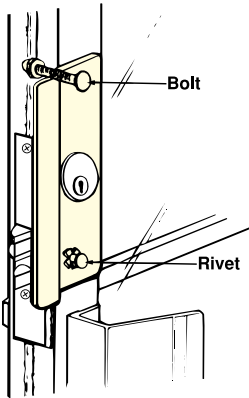

LP307

For ALUMINUM ENTRANCE doors

- Reversible
- Fits over cylinder - lock removal NOT required
- Hand carriage bolt and rivet supplied
- No specific tools required
- 3/8" offset, Display Package Size - 4" x 12"

Stocked Product

LP307 2-5/8" x 7" x 3/8"

Finish:
SL (Silver Coated)
630 (Stainless)

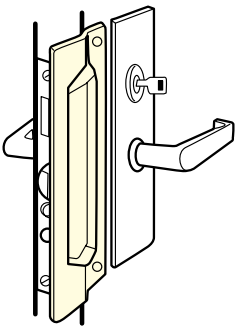

MLP111 / MLP211

For OUTSWINGING DOORS - completely covers the strike plate

- Furnished with carriage bolts, washers & acorn cap nuts for safety and strengths

Stocked Product

MLP111 3" x 11"
Finish: 630 (Stainless)

MLP211 3" x 11"
Finish: SL (Silver Coated)

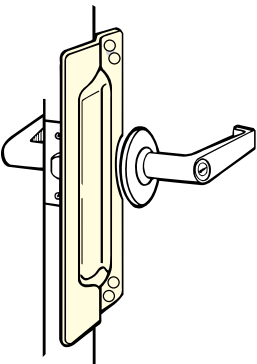

LP111 / LP211

For Outswinging Doors Completely Covers Strike Pate

- Furnished with carriage bolts, washers & acorn cap nuts for safety and strength
- Fits 2 3/4" and 2 3/8" backsets

Stocked Product

LP111 3" x 11"
Finish: 630 (Stainless)

LP211 3" x 11"
Finish: DU (Duro Coated)
Finish: SL (Silver Coated),



Don-Jo Lock Guard Plates

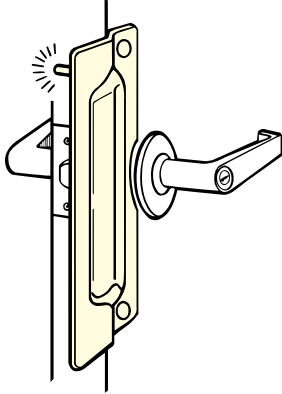

PLP111 / PLP211

Pin Latch protectors for OUTSWINGING DOORS

- Solid steel pin prevents spreading of door from frame
- Pin is welded on back leaving no visible point of attack from outside
- Fits 2 3/4" and 2 3/8" backsets

Stocked Product

PLP111 3" x 11"
Finish: 630 (Stainless)

PLP211 3" x 11"
Finish: 626

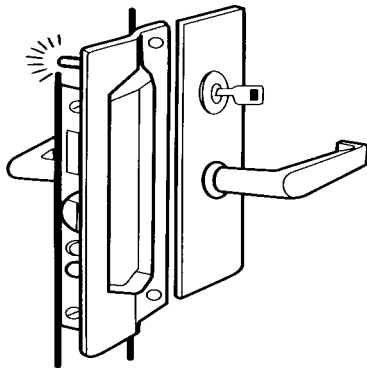

PMLP111

Pin Latch protectors for OUTSWINGING DOORS

- Solid steel pin prevents spreading of door from frame
- Pin is welded on back leaving no visible point of attack from outside

Stocked Product

PMLP111 3" x 11"
Finish: 630 (Stainless)

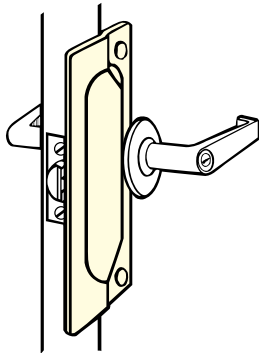

LP107 / LP207

For OUTSWINGING DOORS

- Furnished with carriage bolts, washers & acorn cap nuts for safety and strength

Stocked Product

LP107 2-3/4" x 7"
Finish: 630 (Stainless)

LP207 2-3/4" x 7"
Finishes:
DU (Duro Coated)
SL (Silver Coated)

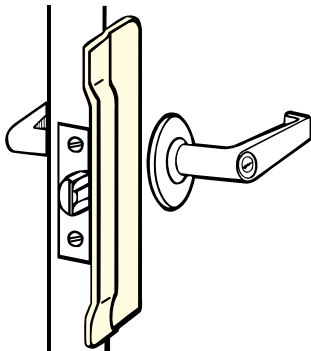

CLP110

For COMMERCIAL TYPE for outswinging doors

- 6" for key-in-knobs
- 10" for Mortise Locks
- Architectural design
- Concealed welded studs with fasteners

Stocked Product

CLP110 2-1/8" x 10"
Finish: 630 (Stainless)



Don-Jo Lock Guard Plates

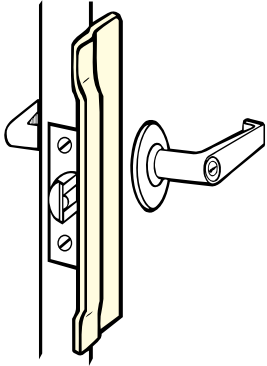

NLP-210 NARROW COMMERCIAL TYPE for outswinging doors

- 6" for key-in-knobs
- 10" for Mortise Locks
- Narrow type for outswinging doors

Stocked Product

NLP210 1-1/2" x 10"

Finish: SL (Silver Coated)

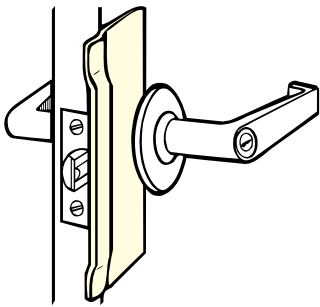

BLP107/BLP207 For KEY-IN-LEVER Locks with up to 3-3/4" ESCUTCHEON

- Works with up to 3 3/4" rose
- Concealed welded studs with fasteners

Stocked Product

BLP107 3-1/4" x 7"

Finish: 630 (Stainless)

BLP207 3-1/4" x 7"

Finish: SL (Silver Coated)

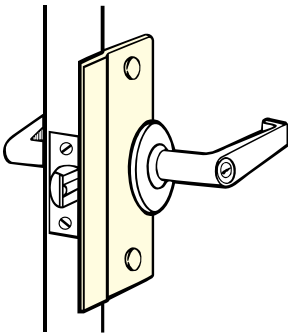

SLP206 SHORT TYPE for outswinging doors

- Furnished with carriage bolts, washers & acorn cap nuts for safety and strength
- May be used on hollow metal door/frame using ANSI strike
- Works with up to 3 3/4" roses

Stocked Product

SLP206 2 5/8" x 6"

Finishes:

DU (Duro Coated)

SL (Silver Coated)

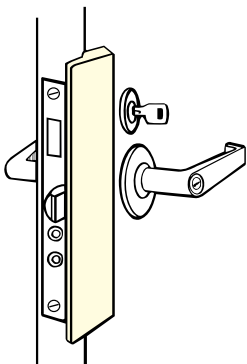

LP2878 SLIMLINE for outswinging doors

- Fasteners included
- Sleek appearance

Stocked Product

LP2878 1-1/2" x 8-7/8"

Finish:

SL (Silver Coated)



Don-Jo - Decal

Decals



HD-1
4" x 4"

White on Blue

THIS DOOR TO REMAIN UNLOCKED DURING BUSINESS HOURS

- DD-1/DD-2
1 1/2" x 24"
- DD1 Black on Clear
- DD2 White on Black

THESE DOORS TO REMAIN UNLOCKED DURING BUSINESS HOURS

- DD-3/DD-4
1 1/2" x 24"
- DD3 Black on Clear
- DD4 White on Black

THIS DOOR TO REMAIN UNLOCKED WHILE BUILDING IS OCCUPIED

- DD-5/DD-6
1 1/2" x 24"
- DD5 Black on Clear
- DD6 White on Black

THESE DOORS TO REMAIN UNLOCKED WHILE BUILDING IS OCCUPIED

- DD-7/DD-8
1 1/2" x 24"
- DD7 Black on Clear
- DD8 White on Black

Signs

TITLE 24 SIGNS



CHS 9

ADA SIGNS



HS 9070 33

Stocked Product

Item	Description	Finish
HD1	4" x 4" DECAL	White on Blue
DD1	THIS DOOR...BUSINESS HOURS	Black on Clear
DD2	THIS DOOR...BUSINESS HOURS	White on Black
DD3	THESE DOORS...BUSINESS HOURS	Black on Clear
DD4	THESE DOORS...BUSINESS HOURS	White on Black
DD5	THIS DOOR...OCCUPIED	Black on Clear
DD6	THIS DOOR...OCCUPIED	White on Black
DD7	THESE DOORS...OCCUPIED	Black on Clear
DD8	THESE DOORS...OCCUPIED	White on Black
CHS9	ALL GENDER RESTROOM NO BRAILLE	White on Blue
HS907033	ADA ALL GENDER RESTROOM W/BRAILLE	White on Blue



Don-Jo - Architectural Accessories

#K0050

ANSI J102 Metal

Used on doors subject to marring or damage from foot traffic.

ANSI

COMMERCIAL KICK PLATES

- Individually packaged with screws
- Fully threaded to the head stainless steel sheet metal screws plated to finish
- Beveled, 4 edged (B4E)
- Commercial grade thickness
- Kick plate screws only
Specify 9DJOKPS + FINISH

Stocked Product

P/N	Size	Finishes
K0050	6" x 34"	630
K0050	8" x 30"	630
K0050	8" x 34"	605, 613, 630
K0050	10" x 30"	630
K0050	10" x 32"	630
K0050	10" x 34"	605, 613, 628, 630
K0050	10" x 40"	605, 613, 630
K0050	10" x 46"	630
K0050	12" x 34"	630
K0050	36" x 34"	630
KPS605	Kickplate screws 605, 613, 630	

ARMOR PLATES

- Commercial grade thickness
- Stainless Steel 630
- 36"x 34" Stock

KICK PLATE

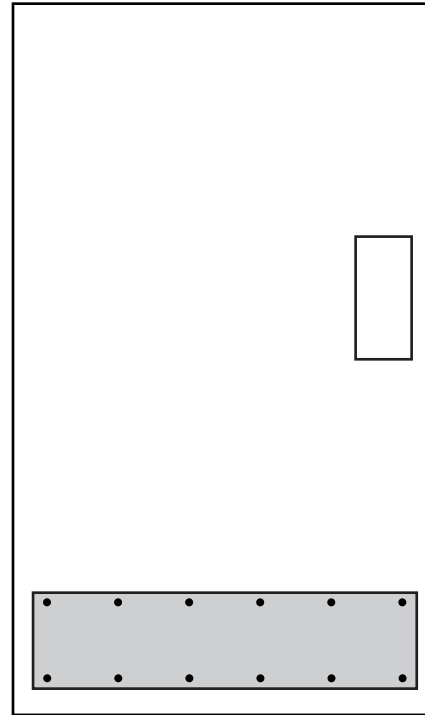

ARMOR PLATE

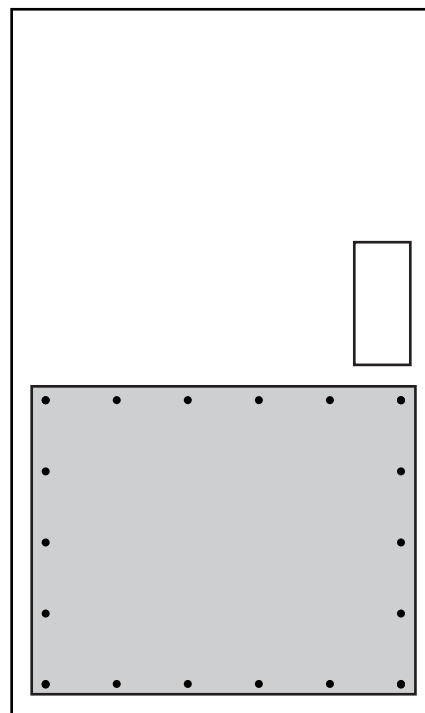



Don-Jo Wrap Around

The Classic Wrap-Around advantage

22(.32) Gauge

includes:

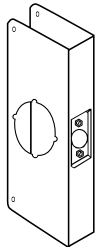
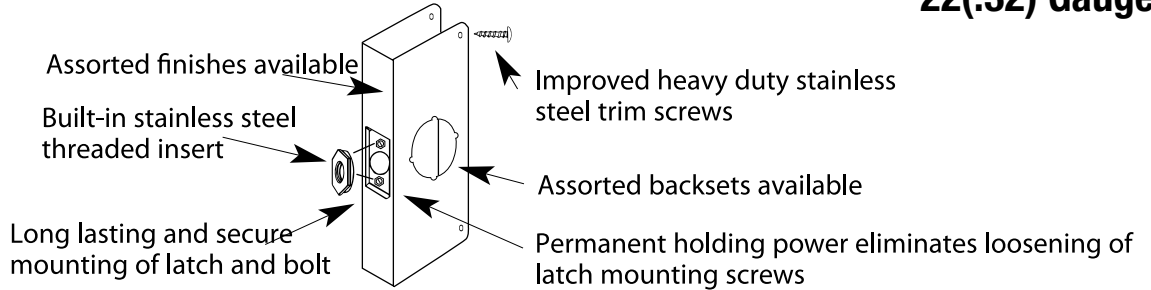

Model 3

For CYLINDRICAL DOOR LOCKS with 2 1/8" hole

#	BACKSET	DOOR	DIMENSIONS
3	2-3/4"	1-3/8"	4-1/4" x 9"

Stocked Product

Finishes:
Polished Brass (PB)
Stainless Steel (S)

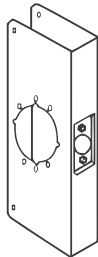

Model 4-2

For use with Heavy Duty Grade 1 & Grade 2 Key-in Levers

#	BACKSET	DOOR	DIMENSIONS
4	2-3/4"	1-3/4"	4-1/4" x 9"

Stocked Product

Finishes:
Stainless Steel (S)

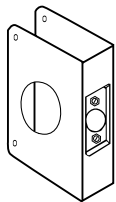

Model 8

For DEADBOLTS with 1 1/2" hole

BACKSET	DOOR	DIMENSIONS
2-3/4"	1-3/4"	4-1/4" x 4-1/2"

Stocked Product

Finishes:
Polished Brass (PB)
Stainless Steel (S)

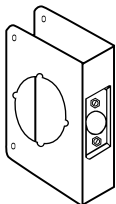

Model 61, 81

For CYLINDRICAL DOOR LOCKS with 2 1/8" hole

#	BACKSET	DOOR	DIMENSIONS
61	2-3/8"	1-3/4"	4" x 4-1/2"
81	2-3/4"	1-3/4"	4-1/4" x 4-1/2"

Stocked Product

Finishes:
Polished Brass (PB)
Stainless Steel (S)

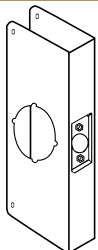

Model 12

For CYLINDER DOOR LOCKS with 2 1/8" hole, 12" height

BACKSET	DOOR	DIMENSIONS
2-3/4"	1-3/4"	4-1/4" x 12"

Stocked Product

Finishes:
Polished Brass (PB)
Stainless Steel (S)



Don-Jo Wrap Around

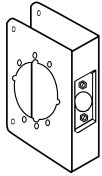

Model 81-2

For use with **HEAVY DUTY GRADE 1 & GRADE 2 key-in-levers**

BACKSET	DOOR	DIMENSIONS
2-3/4"	1-3/4"	4-3/4" x 4-1/2"

Stocked Product

Finishes:
Polished Brass (PB)
Stainless Steel (S)

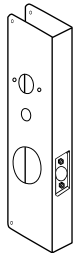

Model 15

Fits **SIMPLEX/UNICAN 1000 SERIES & 4000 SERIES**

BACKSET	DOOR	DIMENSIONS
2-3/4"	1-3/4"	5" x 15"

Stocked Product

Finishes:
Stainless Steel (S)



Model 5000

Fits **SIMPLEX/UNICAN 5000 SERIES**

BACKSET	DOOR	DIMENSIONS
2-3/4"	1-3/4"	5" x 15"

Stocked Product

Finishes:
Stainless Steel (S)

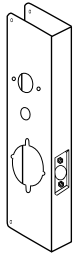

Model 27

Fits **ALARM LOCK 2700/T2 & 3000 SERIES TRYLOGY LOCK**

BACKSET	DOOR	DIMENSIONS
2-3/4"	1-3/4"	5" x 15"

Stocked Product

Finishes:
Stainless Steel (S)

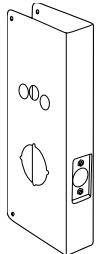

Model 18

Fits **SCHLAGE COBRA LOCKS**

BACKSET	DOOR	DIMENSIONS
2-3/4"	1-3/4"	5" x 15"

Stocked Product

Finishes:
Stainless Steel (S)

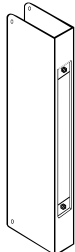

Model 504

MORTISE LOCK wrap-around plate for 86 cut-out

BACKSET	DOOR	DIMENSIONS
-	1-3/4"	5" x 12"

Stocked Product

Finishes:
Stainless Steel (S)