

# MULTIFAMILY DEVELOPMENT

Residential, Mixed-Use, Student Housing  
& Assisted-Living



*ONE CALL DELIVERS IT ALL*

Whether it's new construction or retrofitting existing sites,  
ABS offers the resources for all phases of your multifamily project.



## ABOUT ABS

ABS, or American Building Supply, began in 1985 when it acquired a small family-owned building products company in Sacramento, California. They quickly introduced an innovative overnight loading program, which was a novel concept in the market at the time. This program allowed ABS to guarantee next-day delivery, setting it apart from its competitors. This customer-focused approach helped establish ABS's presence in the market and set a new standard for the industry. With locations in California, Arizona, Washington, Colorado, and Texas, ABS is still an industry leader in the business-to-business material supply chain for door-related products. ABS and its employees operate 6 distribution centers and 2 manufacturing facilities in 5 states. ABS also maintains a fleet of delivery trucks which safely drive over 5 million miles per year.

In addition to distribution, ABS also proudly manufactures doors and door-related products under the registered trademarks of Millennium Door® and Doormerica®.

In 2020, ABS became a wholly-owned subsidiary of JELD-WEN and is one of the nation's largest distributors and manufacturers of quality doors, hardware, windows, and millwork.

After 35 years in business, ABS continues to remain committed to delivering unwavering and impeccable service to our valued customers, 100% of the time.

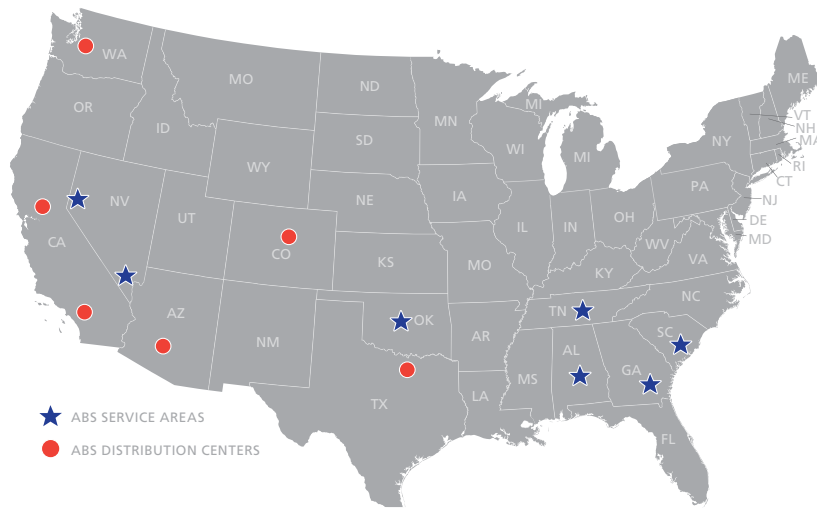

### FEATURING ALL THE BRANDS YOU TRUST

For decades ABS has been a solutions provider to the multifamily industry, your partner providing beauty, safety, and security, through a comprehensive door and door hardware portfolio. You can be assured that the products you receive from ABS brands and partners will be the right fit, form and stylish function, at the right price to make every project a success.



## ENTRY DOORS - FIBERGLASS

### Fiberglass Doors

ABS offers a wide portfolio of fiberglass doors and door systems. There are multiple configurations available along with numerous value-added services. These beautiful and low-maintenance doors are the perfect fit for any project, whether it is residential, multi-family, mixed-use, or commercial. With endless architectural styles and glass combinations, you're sure to find the right look and feel for your project. Take advantage of our wide selection of traditional, craftsman, contemporary, or modern designs to enhance your property with low-maintenance, energy-efficiency, and security options.

A fiberglass entry door system will continue to look and perform beautifully while also providing durability, comfort, and privacy to the occupants. Not only do fiberglass doors offer the depth and warmth of real wood, these doors will contribute to the home's energy efficiency by helping to maintain the desired indoor temperature throughout the seasons.

In addition to the long-lasting beauty of a fiberglass door, property owners will appreciate the low-maintenance performance these doors offer.

With a code-compliant layout and fire rating capabilities, we offer a fiberglass door to meet your specific design, application, environmental, and budget needs.

**For configurations or services visit [www.abs-abs.com](http://www.abs-abs.com) or contact a local ABS dealer near you.**



- TDI and Dade County Tested and impact-rated
- 6'8" and 8'0"
- Available Single, Pair, Sidelite, or Transom
- Stiles prevent water infiltration and ensures that the door will NEVER warp, rot, or rust.

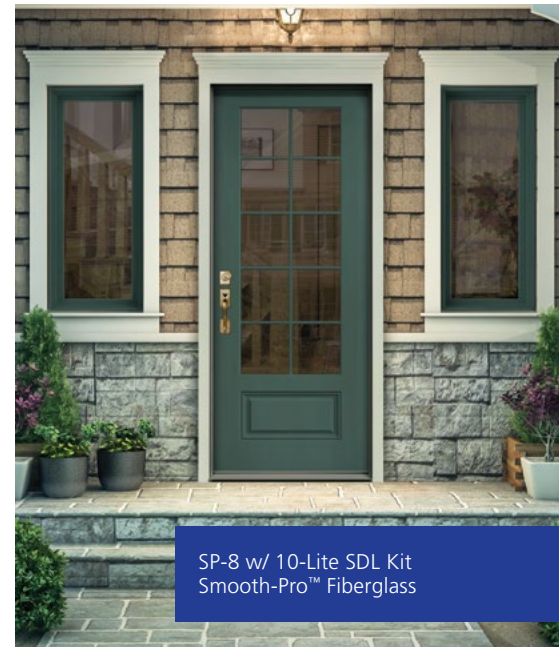
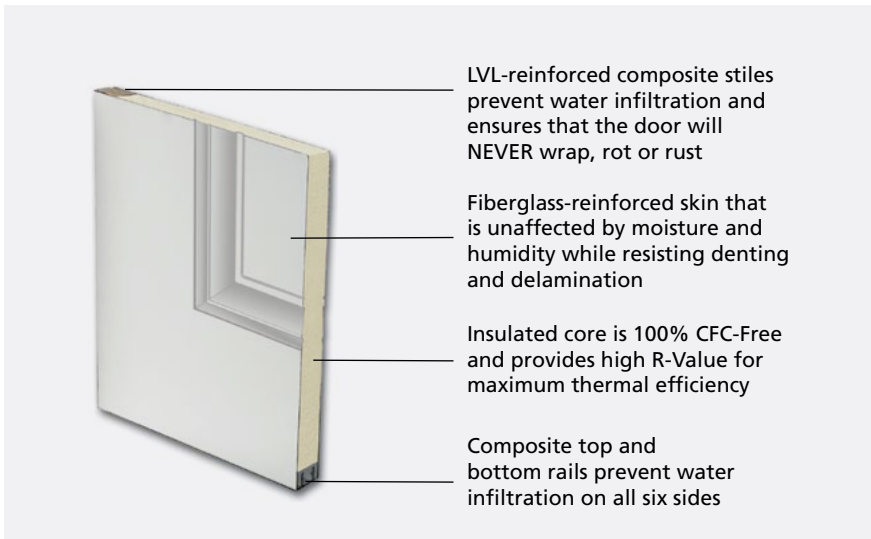



## ENTRY DOORS - STEEL

### Contour Steel Doors

ABS offers a diverse selection of exterior steel doors providing an excellent option for any project requiring a budget-friendly and code-compliant alternative to difficult exposures, especially coastal applications.

Contour Steel doors offer a great insulation value to help maintain your indoor temperature even if the outdoor climate varies.

The 24-gauge galvanized steel and baked-on enamel primer provides a superior surface for paint-resisting rust and corrosion, even direct sea salt spray.

With 20 and 90-Minute fire rating options, standard double-hip, raised panel and code-compliant layouts and an impressive warranty, the Contour door will bring beauty and value to your project.

Several designs qualify for the Energy Star® Program. Please refer to [www.abs-abs.com](http://www.abs-abs.com) for a complete list of our qualifying products.

(Qualification based on 2018 Energy Star® Program - criteria can change)



Double Hip Panel Design



**JELD-WEN**

**Wood and Steel edge stiles create strength and stability.**

One piece polystyrene core provides a custom fit, eliminating core voids and delivering long-lasting insulation.

Primed to prevent rusting.

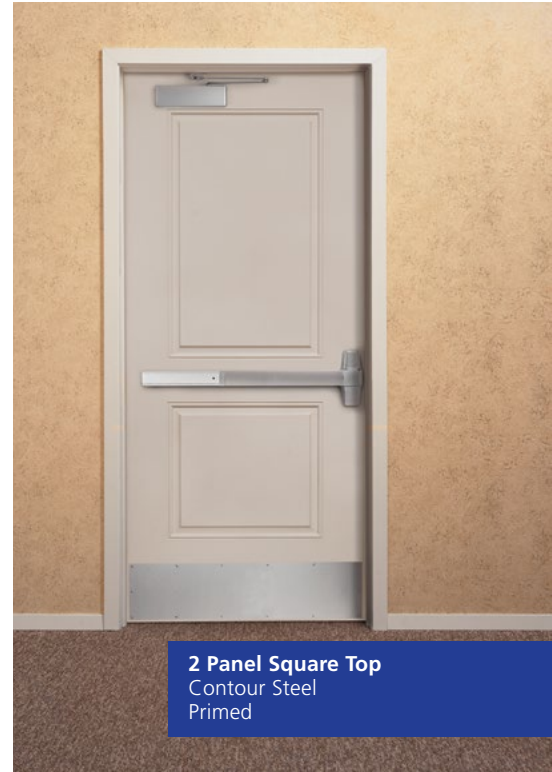
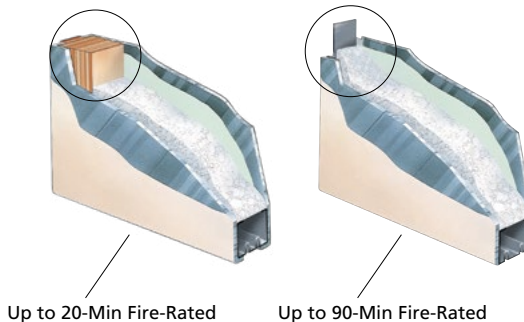

**2 Panel Square Top**  
Contour Steel  
Primed



**Steel French Doors**  
10-Lite

# ENTRY DOORS - FIRE-RATED

## 20 & 90-Minute Fire-Rated Doors

ABS is proud to offer fire-rated door assemblies constructed of materials that work to slow or stop the spread of flames, prevent smoke and gas, and deter radiant heat transference. Common materials include steel up to 90 minutes and fiberglass up to 60 minutes.

These doors can help prevent the spread of flames from 20 to 90 minutes, allowing ample time for emergency services to put out the fire, evacuate people, and save what remains of your property.

Fire-resistant doors save lives.



### 2 Main Benefits of Fire-Rated Doors

**Creates a barrier** between you and the fire along the path of evacuation.

**Reduces the rate of damage** to your property and the premises.

*When ordered, assembly comes with the appropriate materials and labels to meet the rating requirements requested as described in NFPA 80, NFPA 252, UL10B, UL10C*

#### Prehung Units Include

- 4-9/16" Prime Frame
- Fixed Aluminum Sill
- Compression Weatherstrip
- US-4 Hinges
- 20-Minute Fire-Rated Labeled Door

#### Additional Prehung Options Available

##### PREP

- 2-1/8" Deadbolt Prep
- 1/2" Peep Prep
- 1/2" Satin Nickel Peep Prep & Install

##### SILL

- Low Profile Sill (ADA Compliant)

##### FRAMES

- 5-1/4" Frame
- 6-9/16" Frame
- 4-9/16" 20-Minute Frame
- 7-1/4" 20-Minute Frame
- Brick Mold

##### HINGES

- US-1D Black
- US-3 Bright Brass Chrome
- US-3/4 Dark Brass
- US-15 Satin Nickel
- US-26 Bright Chrome
- US-26D Brushed Chrome

#### FIRE RATING 20 MIN WOOD FRAMES



Fiberglass Smooth 6 Panel, Fiberglass Smooth 2 Panel, Fiberglass Smooth 2 Panel Archtop, Fiberglass Smooth 2 Panel Planked, Fiberglass Smooth 1 Panel Shaker, Fiberglass Smooth 2 Panel Shaker, Fiberglass Smooth 3 Panel Shaker



Contour Steel Flush, Contour Steel 2 Panel, Contour Steel 6 Panel, Contour Steel 2 Panel Archtop, Contour Steel 4 Panel, Contour Steel 3 Panel, Contour Steel 1 Panel Shaker, Contour Steel 2 Panel Shaker, Contour Steel 3 Panel Shaker

#### FIRE RATING 90 MIN STEEL FRAMES



Contour Steel Flush, Contour Steel 2 Panel, Contour Steel 6 Panel, Contour Steel 2 Panel Archtop, Contour Steel 4 Panel, Contour Steel 3 Panel

#### SPECIAL ORDER



Contour Steel 1 Panel Shaker, Contour Steel 2 Panel Shaker, Contour Steel 3 Panel Shaker



Contour Steel 20 Minute Fire-Rated Door



# INTERIOR DOORS - PREMIUM MANUFACTURED

## Millennium® Collection

The Millennium® Collection consists of four distinct families of door products, each designed to complement a specific architectural design and build specification. Encore, Ovation, Infinity, and Bravo Doors are all manufactured from renewable composite wood fiber materials for stability and reliability. Their state-of-the-art design and environmentally friendly construction techniques mean endless flexibility for your project needs. The Millennium Collection will provide unique solutions to any paint-grade door application requirement. For all options visit [www.abs-abs.com](http://www.abs-abs.com) or a local dealer near you.



### Encore - Router Carved, Raised Panel Only

When you are looking for diverse options with split design capabilities. The Encore door offers over 150 standard designs with 90% being the same cost. Costs are controlled by router carving each face using CNC technology, then fiberfusing the faces together. The independent routing of each face allows for split design capability. You can insert a full-length dress mirror, dry-erase marker, or chalkboard on the opposing side of your panel design. Size capabilities range from 4'-0" wide to 8'-0" tall, in both 1-3/8" and 1-3/4" thick, and fire rating from 20 to 90 minutes available.

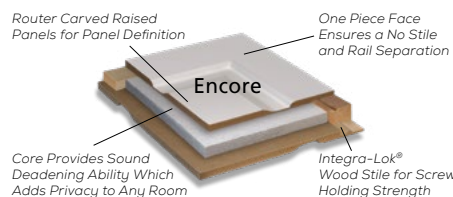

### Ovation® - Layered, Raised Panel, Flat Panel, Bolection Molding

Think of this door series like an Oreo cookie - an outer layer (face 1), a core (panel) and an opposing outer layer (face 2). Choose from a wide selection of more than 140 designs, each of which can be uniquely tailored to meet your specific requirements - face, panels, and even multiple sticking profiles. Though split designing is limited to flat panel configurations, the options for false or ventilated louvers is an option. Size capabilities range from 4'-0" wide to 8'-0" tall in both 1-3/8" and 1-3/4" thick, and fire rating from 20 to 90 minutes available.

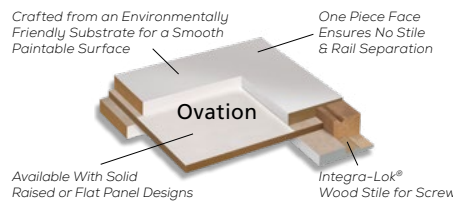

### Infinity - Traditional Inlaid Raised or Flush Molding

With over 120 designs and a myriad of split design options. The Infinity collection brings elegant style with dramatic hip- raised panel flair with three styles of flush or raised molding. In addition to louvers, chalk, and dry-erase boards, we provide a diverse range of decorative glass inserts including clear, obscure, white laminated, and mirror options. Size capabilities range from 5'-0" wide to 10'-0" tall in both 1-3/8" and 1-3/4" thick, and fire rating from 20 to 90 minutes is available.

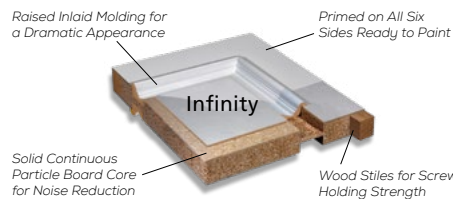

### Bravo - True Stile and Rail

This collection is up for the challenge when it comes to historical renovation coupled with affordability, quality, and consistency. With over 51 standard design options and 20-minute fire rating capabilities, utilizing historic design with 21st-century technology, the Bravo collection will get the job done.

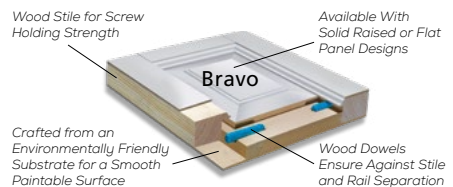

## Specialty Doors

The Millennium® Collection offers a myriad of flexible design options, and everything in between. By applying modern technology and reliable construction, specialty doors can easily become a reality. We offer a series of glass doors ranging from clear to mirrored as well as louvers in both ventilated or false. In addition to these options we offer magnetic chalk and dry-erase board doors as a split design - allowing for creativity on one side and formal beauty on the other.



All of these options are available in various configurations, including singles, pairs, bi-folding, pocket, bypass, or barn sliding configurations. Visit [www.dooramerica.com](http://www.dooramerica.com) for full details and offerings.



**All products listed are available prehung or prefit by skilled American Building Supply craftsmen to exacting standards with the highest level of scrutiny.**

## INTERIOR DOORS - ECONOMY & CONSTRUCTION

### Doormerica American Series Collection

#### Architectural Flush and Commercial Wood Doors:

We offer a full line of residential, light commercial, and architectural grade doors ranging from economy to extra heavy duty. Providing a wide array of door products from paint-grade, hardwood, and plastic laminate in 3 or 5-ply construction. We comply with WDMA industry standards including our factory prefinished Architectural doors in various species and opaque finishes, coupled with our extensive fire, sound transmission, and environmental certifications available on many products.

With 9 standard transparent finishes and an extensive range of developed colors, including custom capabilities, the options are endless. American Series doors meet or exceed WDMA I.S. 1A, in both A Grade and AA Grade veneers, utilizing a wide variety of species, slicing, and assembly methods.

American Series is the perfect fit for your project:

- Rating capabilities from 20 - 90 minutes
- Both category A and B, coupled with 1-3/8" or 1-3/4" thick in either hollow core or solid core
- Loose lay-up or bonded construction in sizes from 5'-0" wide to 10'-0" tall

### Steel Storage Balcony Door

- Very cost-effective space saver for multifamily projects.
- Provides a secure ventilated door on any balcony.
- Inverted louvers allow free air-flow to prevent mold and mildew.
- This 24-gauge galvanized steel door will withstand the outside elements and keep your valuables safe.
- Available in either 1-3/8" or 1-3/4" thick and both 6'-8" or 8'-0" tall, they are perfectly sized to meet the balcony space requirements and provide wood stiles and rails for easy hardware fitting and installation.
- ABS can provide hinge and bore locations to meet your existing frame and hardware, or you can simply purchase a new door frame and hardware assembly.



For full product offerings and available downloads visit a local dealer near you, [www.abs-abs.com](http://www.abs-abs.com), or [doormerica.com](http://doormerica.com)

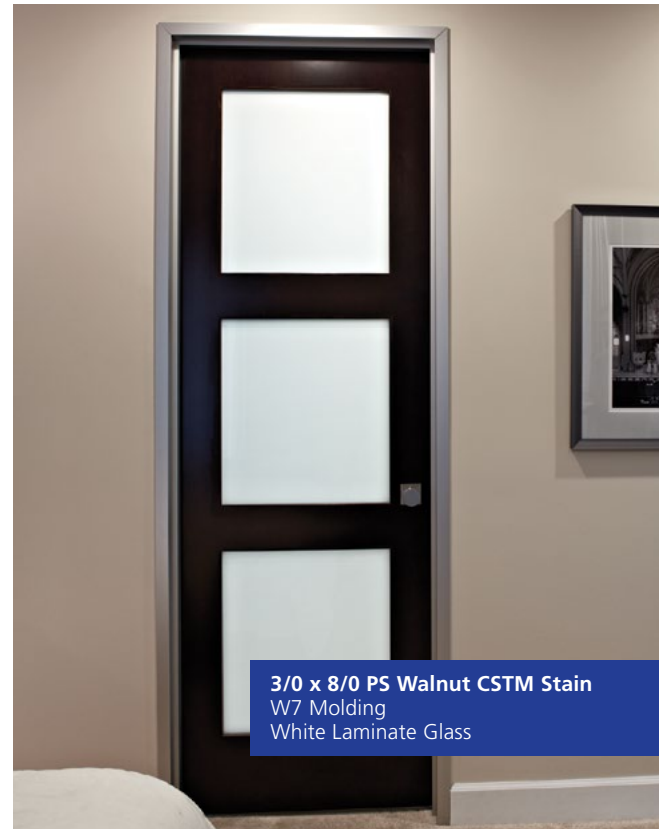



## INTERIOR DOORS - DISTINCT STYLE



Conmore  
Molded

### Molded Doors

Interior molded doors are available in a diverse range of options, encompassing numerous styles, panel designs, and sizes. Both single and double doors can be ordered as prehung units that are ready for installation, with the added benefit of being available in multiple jamb species and featuring an array of decorative hinge finish options.

These doors mimic the look of classic wood at a much more budget-friendly price, while also providing superior durability and a broader range of design options. In new construction, their versatile design and ease of installation is prized. In renovation projects, replacing an outdated or damaged door is considered one of the simplest and most cost-effective ways to update the appearance of a room.

Hollow core doors have made great strides in quality compared to the early years and are lightweight and easy to move and install.

ProCore Solid core doors provide the same surface appearance but contain sound-reducing material on the inside. Great for bathrooms, game rooms, music rooms, bedrooms, offices, etc.

All of our molded Interior doors can be used for barn, bifold, bypass, and pocket door systems. All required hardware can be supplied, including our barn door hardware. (See page 8 for more information.)

- Multiple architectural styles and designs
- Eco-friendly construction.
- 1-3/8 & 1-3/4
- Up to 3/0 in width and 8/0 in height
- Flat-panel and raised-panel options
- Contemporary and traditional designs
- 20-Minute fire rating capabilities



Caiman  
Molded





15-Lite French Outswing



7102 Ovation  
Pocket door

## PATIO DOORS

ABS offers a variety of distinctive patio door styles. Whether it's high-exposure or high-end, ABS has a patio door system to fit your design, climate, and budget needs.

These systems provide a wide range of style and comfort options featuring insulated glass and are available in either fiberglass or galvanized steel.

Available in single, pair, triple, or quad configurations, and full-glass to 15-lite, you're guaranteed to find the right design for your project.

Insulated glass will provide comfort and help control the interior climate and utility cost by increasing the property's R-Values.

Choose from a variety of door systems: swinging, folding or sliding operation, and have your slabs prepped accordingly.

Check with your local dealer for door type availability or visit [www.ABS-ABS.com](http://www.ABS-ABS.com)



F-2500  
Folding Patio Door

## POCKET DOORS & HARDWARE

Pocket doors are a smart and versatile use of space, saving valuable square-footage while still maintaining your project style requirements.

Our pocket door hardware offers four-wheel rollers on a jump-proof track and easily adjusts after installation. Choose from boxed or assembled built-up frames for quick installation on the job site.

### Features

- Built-up wood frame for easy installation
- Door thickness of 1-3/8" and weight up to 150 lbs.
- Four-wheel roller on v-groove jump proof track
- Easy adjustment after installation



Upgrade your pocket door frame to a premium, heavy-duty Cavity Slider frame with optional Sof-Stop® soft close/open capability and a variety of innovative hardware options.

SLIDING DOOR POCKETS - Built Up Frame	
DOOR SIZE	6/8 HEIGHT
2/0 x 6/8	50" x 84"
2/4 x 6/8	58" x 84"
2/6 x 6/8	62" x 84"
2/8 x 6/8	66" x 84"
3/0 x 6/8	74" x 84"



## BARN DOORS & HARDWARE

American Building Supply takes pride in offering a combination of style and practicality. These barn doors provide a fresh and unique twist on a traditional and timeless look. With the option for field finishing, these doors are ideal for openings ranging from 28" to 42" wide and 96" tall. Offering an extensive collection of over 150 door designs, you can make a bold statement in any room.

Barn door style hardware allows for a more functional space by enabling the door to slide parallel to the wall and is grade 1 tested. These barn door kits offer a diverse design from simply modern to rustic, allowing doors up to 250lbs to smoothly float unobstructed and meet all required codes.

In addition, the barn door hardware kits are available for separate purchase in various styles and finishes.

If you would like to learn more about the barn doors and hardware we sell, please visit our website at [www.abs-abs.com](http://www.abs-abs.com).



Encore 6659  
Type 5 Barn Door Hardware

### Available Rustic Styles



Mini Industrial  
Flat Black



Mini Industrial  
Satin Nickel



Mini Modern  
Silver



Mini Ultra Modern  
Flat Black



### Available Premium Styles



Type 1



Type 2



Type 4



Type 5

## INTERIOR DOORS - SPECIALTY

Let ABS add practical elegance to a living area or home office with beautifully-crafted French doors. Our attractive and affordable decorative series doors add elegance and privacy while maintaining brightness from one room to the next. These interior designer doors have tempered glass for extra strength and safety. Most feature a unique protective glass wrap that makes staining and finishing a snap. We provide a wide array of 13 glass and two stile and rail options. These doors are perfect for swinging, sliding, or pocketed applications. Available in both 6'-8" and 8'-0" tall and 1-3/8" thick doors.



**1-Lite Pantry**  
French Door

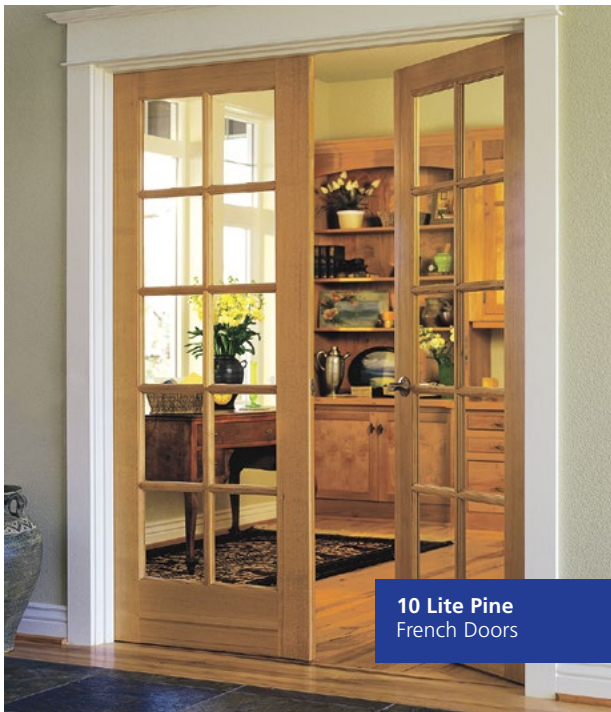

**10 Lite Pine**  
French Doors

### Glass Privacy Rating

If privacy is a concern, each glass option is offered with our privacy rating from obscure to clear.

OBSCURE						CLEAR			
1	2	3	4	5	6	7	8	9	10

#### Glass Design Options

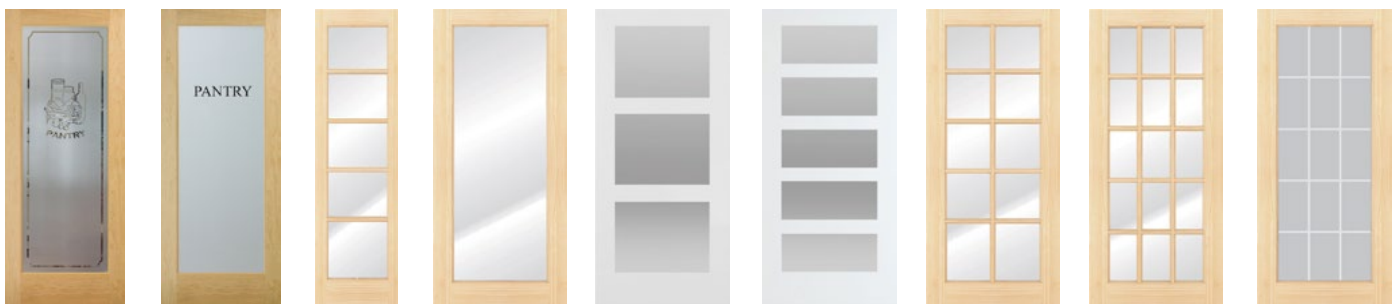
**1-LITE PANTRY OBSCURED**  
Ovolo  
Tempered Glass

**1-LITE MODERN PANTRY OBSCURED**  
Ovolo  
Tempered Glass

**5-LITE CLEAR**  
True Divided  
Ovolo  
Tempered Glass

**1-LITE CLEAR**  
Ovolo  
Tempered Glass

**3-LITE FROSTED**  
Shaker  
Tempered Glass

**5-LITE FROSTED**  
Shaker  
Tempered Glass

**10-LITE CLEAR**  
True Divided  
Ovolo  
Tempered Glass

**15-LITE CLEAR**  
True Divided  
Ovolo  
Tempered Glass

**15-LITE CLEAR**  
V-Groove  
Ovolo  
Tempered Glass

For more information on glass privacy ratings, please see a copy of our Doormerica Decorative Door literature on [www.abs-abs.com](http://www.abs-abs.com)

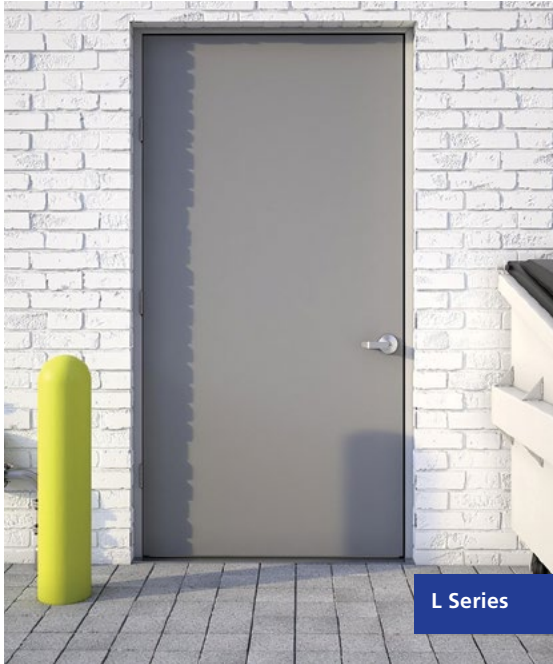

## COMMERCIAL DOORS

### Steelcraft L Series and Falcon Doors

**L Series Flush Doors** are designed to meet the SDI requirements for full flush doors. This premium standard door construction combines a beveled lock and hinge side, strong epoxy-filled interlock edges, and unsurpassed 7-gauge hinge reinforcement. The continuous bonding of the laminated core to steel face sheets provides an attractive, flat door which is free of face welding marks. Tests have proven that the L Series door has a high resistance to impact damage, low thermal conductivity, and high STC ratings. The honeycomb core is constructed with 16/18-gauge steel and with fire ratings up to 3 hours. Each door is designed to meet the meticulous standards of SDI A250.8 with inverted top and bottom channels and standard closer reinforcement.

**Falcon Commercial Doors** are an affordable non-handed, square-edge door solution designed to meet your requirements for commercial quality full flush steel doors. These Flush doors are designed to meet the architectural requirements for full flush 18-gauge heavy-duty doors. The continuous bonding of the laminated core to steel face sheets provides an attractive, smooth door comprised of cold rolled steel with honeycomb core, and 18-gauge, with fire rating capabilities up to 3 hours.

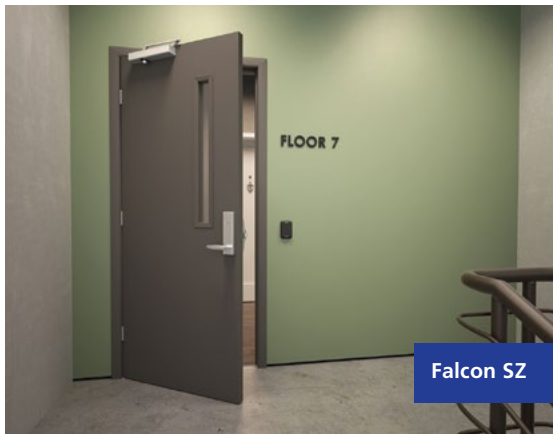

### Features

- Designed for institutional, commercial, and industrial applications, Steelcraft provides an impressive selection of hollow metal products for virtually every wall condition and entryway requirement.
- The standard honeycomb core system helps control thermal bow in high exposure applications. The beveled "L" Series door offers tighter margins and better performance against hinge bind. The standard field adjustable hinge depth offers the ability to field modify from a standard .134 hinge to a heavy weight .180 in a matter of minutes, saving time and money.
- The Falcon door is a reversible swing and non-handed door, making it a very price competitive product.
- The "L" Series and Falcon Series each come with standard rust inhibiting primer.
- ABS offers custom fabrication, such as cutouts for vision lites or flush bolts.
- ABS stocks a myriad of accessories in addition to models of the floor for immediate delivery.

### Specification Compliance

Door construction for Steelcraft's Falcon SZ Series doors meets the requirements of ANSI A250.8-2017 (SDI 100).

Hardware preparations and reinforcements are in accordance with ANSI A250.6-2003 (R2009). Locations are in accordance with ANSI/DHI A115 unless otherwise stated.

### Fire Ratings

Falcon SZ Series 20-gauge doors are listed for installations requiring compliance to negative pressure testing (ASTM E152 and UL-10B) and positive pressure standards (UL-10C).

Doors are factory labeled with a Warnock Hersey 1-1/2 hour (90 min) Mylar label.

# STEELCRAFT®

## DOOR FRAMES

### Steelcraft F Series

The F Series three-sided flush frames meet requirements for light- to maximum-duty applications for interior and exterior locations in commercial and industrial buildings. They are designed for installation as part of the wall framing assembly and may be specified and supplied as knock-down (KD) for field assembly prior to installation or welded for installation as a complete unit. This 16-gauge cold rolled steel frame with a standard 4-1/2" tall hinge prep and 4-7/8" ASA prep the "F" Series frame has a maximum fire rating capability of 3 hours. ABS offers a variety of welding and fabrication options, such as sidelites, transoms, and borrowed lites with-or-without mullions.

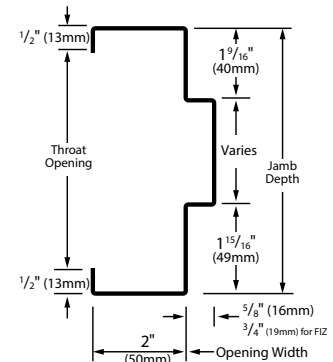

**Steelcraft  
F Series**

### Steelcraft Drywall K Series

The DW Series Drywall frames are designed for light to maximum duty applications in both commercial and institutional buildings. Standard jamb compression anchors and a unique tab/lock corner design for knock-down (KD) assembly assure that the K Series drywall frames install in minutes on finished drywall construction. The K Series frames are designed for interior drywall partitions that wrap a wall that has been sheet-rocked. This 16-gauge cold rolled steel frame with 4-1/2" tall hinge and 4-7/8" ASA strike offer a maximum 90-Minute fire rating capability.

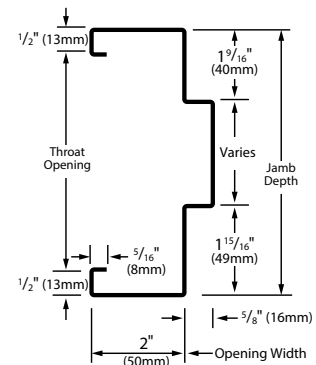

**Steelcraft  
Drywall K Series**

### Timely C Series & S Series

Well-suited for most drywall applications, the Timely Frame has become our most popular frame for interior and exterior applications.

It offers options for 1-3/8" or 1-3/4" thick doors, with fire ratings of up to 90 minutes. The prefinished polyester paint provides a smooth surface ideal for vertical applications. The customizable frame is available in various colors with different prep options available, such as heavy weight, continuous, or electrified hinges, as well as ASA, "T", and Full Lip strikes, pivots, and more.

The Timely prefinished steel frame also offers various casing profiles, such as TA-8, TA-30 Steel, or TA-23 Aluminum. The case-hardened steel clip system ensures that the casing stays tightly attached to the frame, even if it is removed and reapplied. Frames can be ordered without clips for use with wood casing (casing supplied separately)\*.

ABS stocks four standard colors (Black, Brown, White, and Alumaton) at competitive prices. These frames come in both fixed and variable wall conditions, with a standard 4" tall hinge prep for 1-3/4" thick doors and a 3-1/2" tall hinge prep for 1-3/8" thick doors, both including a standard adjustable "T-Strikes".

Whether you need three-sided door frames, a door frame with a sidelite, or a door frame with sidelite and transom combination, ABS can create the perfect system to fit your every need. We can also accommodate custom hardware preps in either standard or non-standard locations.

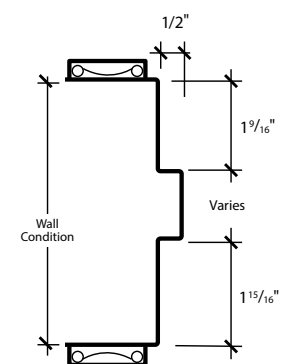

**Timely  
C Series & S Series**

\*Please note that the maximum fire rating decreases to 45 minutes when wood casing is used.





## DOOR HARDWARE & MORE

We stock the full line of Allegion Premium Hardware as well as Doormerica Hardware for budget-conscious projects.

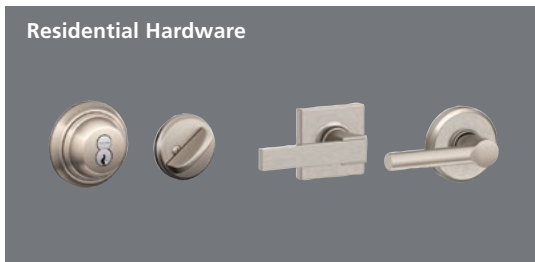

### These Solutions Offer Many Benefits

- Ability to limit accessibility as needed
- Increased security
- Patented key system prohibits the duplication of keys without the authorization of the manufacturer or its contracted locksmith vendor

### ABS Also Offers

- Keying services
- Job accounts to assist with credit limits
- Bundle products and potentially earn additional discounts where available on your doors, frames, and hardware

### Main Entrances

- Multi-technology reader
- Smart credential
- Von Duprin 98/99 EL exit device with trim
- LCN 4040XP closer

### Media Rooms and Common Areas

- Schlage ND Series
- Multi-technology reader
- Smart credential
- Falcon 24/25 EL exit device with trim

### Stairwells and Emergency Exits

- Schlage CO Series (lock or exit trim)
- Smart credential
- Falcon 25 EL exit device
- LCN 4040 closer

### Resident Entrances

- Schlage Control smart lock
- Schlage LE wireless lock
- Smart credential

### Conference Centers and Business Offices

- Schlage NDE lock
- Schlage LE wireless lock
- Smart or multi-technology credential

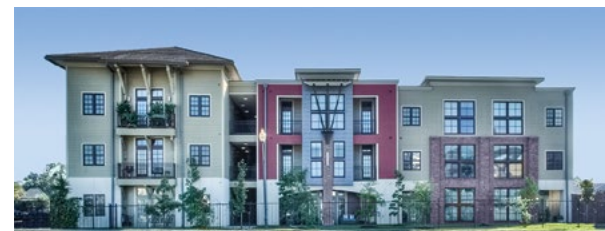

ABS stocks a full line of commercial hardware available for immediate delivery. Offering a variety of self-closing hinges, door closers, panic devices, trim, door viewers, kick and mop plates, push and pulls, wall and door stops, and more.

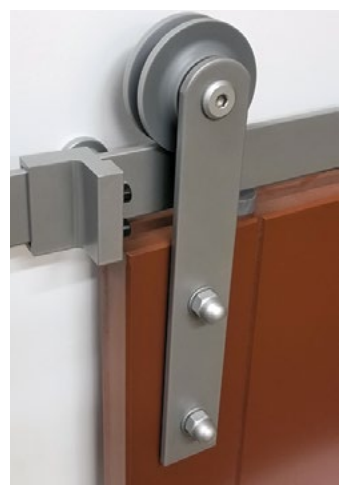
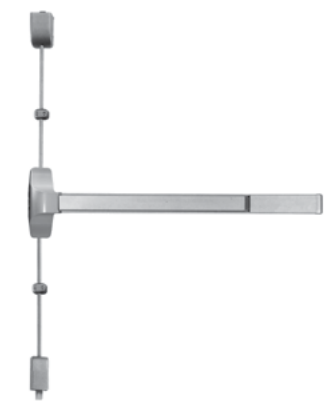
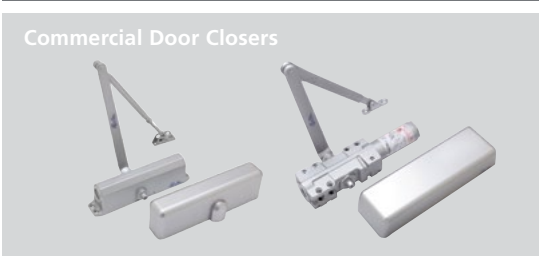
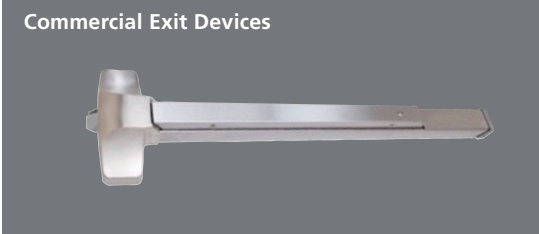

For additional product support for multifamily construction visit [www.doormerichardware.com](http://www.doormerichardware.com)



For more information on  
**ABS products and  
 services, please visit**  
**[abs-abs.com](http://abs-abs.com)**

<b>DALLAS</b>	<b>DENVER</b>	<b>LOS ANGELES</b>	<b>PHOENIX</b>	<b>SACRAMENTO</b>
350 Northpoint Dr Coppell, TX 75019	5025 Florence St Suite D Denver, CO 80238	120 S Cedar Ave Rialto, CA 92376	4635 W McDowell Rd Suite 130 Phoenix, AZ 85035	6300 S Watt Ave Sacramento, CA 95829
469-322-8100	303-576-9200	833-436-6752	602-415-6528	800-527-3667
Fax: 469-322-8122	Fax: 303-576-9222	Fax: 909-879-8701	Fax: 602-415-6520	Fax: 916-379-4285

ABSMULTIFAMILY 02-25