



Thank you for selecting JELD-WEN® products. Attached are JELD-WEN's recommended installation instructions for Exterior Wood, Steel and Fiberglass Pre-Hung Doors. Read these instructions thoroughly before beginning. Not all door types may be installed into every wall condition in all areas. Consult your local building code official for applicable building codes and regulations. Local building code requirements supersede recommended installation instructions. JELD-WEN does not endorse the installation of our products into a barrier-type install system unless a sill pan is present, incorporated with through-wall flashing and can drain to the exterior (along with other "required" components). Failure to do so may result in the denial of any warranty claims. Areas such as Florida and the Texas TDI region have different anchoring requirements based on product certification. For information on specific products, visit [www.floridabuilding.org](http://www.floridabuilding.org) or [www.tdi.texas.gov](http://www.tdi.texas.gov) and follow the anchoring schedule given in the drawings for the product instead of the anchoring schedule in this document.

### IMPORTANT INFORMATION | TABLE OF CONTENTS | GLOSSARY

JELD-WEN does not endorse the installation of our products into a barrier-type install system unless a sill pan is present, incorporated with through-wall flashing and can drain to the exterior (along with other "required" components). Failure to do so may result in the denial of any warranty claims.

**PLEASE NOTE:** Installations, where the sill is higher than 35 feet above ground level or into a wall condition not specifically addressed in these instructions, must be designed by an architect or structural engineer. Failure to install square, level and plumb and on a flat surface (without twist or warp) could result in denial of warranty claims for operational or performance problems.

**NOTE TO INSTALLER:** Provide a copy of these instructions to the building owner. By installing this product, you acknowledge the terms and conditions of the limited warranty as part of the terms of the sale.

#### Table of Contents

|  |    |
|--|----|
| <a href="#">Safety and Handling</a> .....          | 2  |
| <a href="#">Materials and Tools</a> .....          | 2  |
| <a href="#">Inspect Product</a> .....              | 3  |
| <a href="#">Inspect Rough Opening (R.O.)</a> ..... | 4  |
| <a href="#">Install Sill Pan</a> .....             | 5  |
| <a href="#">Install Door</a> .....                 | 6  |
| <a href="#">Install Drip Cap</a> .....             | 9  |
| <a href="#">Create "Interior" Air Seal</a> .....   | 9  |
| <a href="#">Remove Protective Film</a> .....       | 10 |
| <a href="#">After Installation</a> .....           | 10 |

## **CAUTION**

**DO NOT** discard the NFRC label on the product until the final inspection is complete.

## NOTICE

JELD-WEN advises against product installation in high interior water exposure environments such as showers, steam rooms and enclosed pool areas. These areas are beyond the tested/certified design intent of the door and any related warranty claims could be denied on that basis.

#### Glossary

##### Buck

A wood framework attached to the masonry inside a window or a door rough opening.

##### Door System/Pre-Hung Door

A pre-cut and assembled unit consisting of a door slab (prepared for the locking or passage hardware) hung on hinges in a wood or metal frame.

##### Hinge Jamb

The side of the jamb on which the hinges of a door are installed.

##### Rough Opening

The framed opening in a wall where a door is to be installed.

##### Security Plate

A metal plate that is pre-installed into the frame of a pre-hung door. It is designed to provide extra strength and stability from a forced entry attempt by allowing the door's latch to rest inside it when it is closed.

##### Shiplap

The layering method in which each layer overlaps the layer below it so that water runs down the outside.

##### Shipping Strap

Small, metal or plastic clips that come attached to a door system. These clips help keep a door slab closed and aligned before and during installation.

##### Sidelite

A fixed, usually rectangular window placed on either side of a door.

##### Strike Jamb

The side of the jamb that contacts the latch on a door slab.

**SAFETY AND HANDLING**

**Safety**

- Read and fully understand **ALL** manufacturer's instructions before beginning. Failure to follow proper installation instructions may result in the denial of warranty claims for operational or performance problems.
- **DO NOT** work alone. **Two or more people are required.** Use safe lifting techniques.
- Use caution when handling glass. Broken or cracked glass can cause serious injury.
- Wear protective gear (e.g., safety glasses, gloves, ear protection, etc.).
- Operate hand/power tools safely and follow the manufacturer's operating instructions.
- Use caution when working at elevated heights.
- If disturbing existing paint, take proper precautions if lead paint is suspected (commonly used before 1979). Your regional EPA ([www.epa.gov/lead](http://www.epa.gov/lead)) or Consumer Product Safety Commission offices provide information regarding regulations and lead protection.

**⚠ WARNING**

**Drilling, sawing, sanding or machining wood products can expose you to wood dust, a substance known to the State of California to cause cancer. Avoid inhaling wood dust or use a dust mask or other safeguards for personal protection. For more information, go to [www.P65Warnings.ca.gov/wood](http://www.P65Warnings.ca.gov/wood).**

**Materials and Door Handling**

- Heed material manufacturer's handling and application instructions.
- Handle in a vertical position; **DO NOT** carry flat or drag on floor.
- **DO NOT** put stress on joints, corners or frames.
- Store door in a vertical, leaning position to allow air circulation; **DO NOT** stack horizontally.
- Ensure the storage area is dry, well-ventilated and **protected from exposure to direct sunlight.**
- Only install into vertical walls when conditions/sheathing are dry.

**IF INJURY OCCURS, IMMEDIATELY SEEK MEDICAL ATTENTION!**

**MATERIALS AND TOOLS**

JELD-WEN exterior window and door products should be installed in accordance with JELD-WEN's recommended installation and flashing directions, which are shipped with the products or can be found on our website: [www.jeld-wen.com](http://www.jeld-wen.com). **NOTE:** When using flashing, spray adhesive/primer, sealant and foam products, we recommend using the same manufacturer and verifying compatibility. It is the End User's responsibility to determine if dissimilar materials are compatible with the substrates in the application.

**Provided Materials**

- 2 - #9 x 2 1/2" screws.
- Foam weatherstrip wedges (corner seal pads).

**Needed Materials**

- Lock set
- 10d galvanized casing nails (if plan to stain) or #8 x 2 1/2" flat-head screws (if plan to paint).
- Non-compressible, non-water degradable shims.
- Sill Pan: A pan flashing system (as defined in **ASTM E2112**) is **required** at the sill prior to window/door installation. A sill pan should have a positive slope, **must be** installed onto the sill of the R.O. in a weather-tight manner and tied into the drainage plane of the building envelope. For sill pans without a positive slope, place a 3/16"-1/4" tall plastic shim 2" from each corner and no more than 8" on-center in between (excludes Canada and potentially large door systems). If an aftermarket sill pan is preferred, then we suggest the Manufacturer's instructions be followed.
- Backer Rod: 1/8" larger than the widest portion of the gap (used in conjunction with sealant bead).

- Sealant: An exterior grade (**High-Performing, Low VOC**) sealant is recommended for installation practices. Check with the sealant manufacturer for color-match options and paintability.
- Polyurethane Low-Expansion Window and Door Foam: A low-expansion, polyurethane window and door foam is recommended for installation practices. Avoid using moderate to high-expansion products as operational issues or damage may occur.
- Drip cap (if not supplied).

**For installations into a Buck:**

- Liquid applied flashing.

**Needed Tools**

- |                                     |                        |
|-------------------------------------|------------------------|
| • Tape measure                      | • Construction stapler |
| • Utility knife                     | • Hammer               |
| • Level (4 ft. minimum recommended) | • Screwdrivers         |
| • J-roller                          | • Nail set             |
| • Caulking gun                      | • Square               |
| • Drill with bits                   | • Pencil               |
|                                     | • Pry bar              |

### 1

### INSPECT PRODUCT

#### Remove Packaging

- Remove shipping materials such as corner covers, shipping blocks or pads. Remove any staples exposed on the frame, but leave glass protective films.
- If the door unit includes packaging or a skidboard under the threshold and bottom end of the side jamb, remove it.
- If the door comes with a security plate on the outside of the frame at the strike, **DO NOT** remove it. Install the door with the security plate attached.

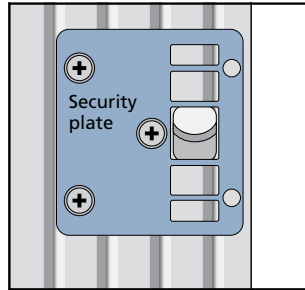
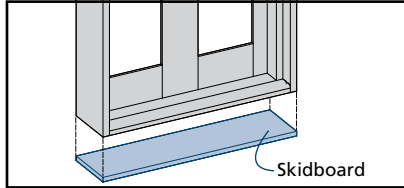

#### Inspect Door

- Cosmetic and/or shipping damage.
- Product squareness (diagonal measurements must be within 1/4" difference).
- Manufacturing abnormalities (e.g., warp, bow, squareness).
- Correct product (size, color, grid pattern, handing (side the hinges are on), glazing, energy-efficiency requirements, etc.).

If any of the above conditions represent a concern, or if you expect environmental conditions to exceed the door's performance rating, **DO NOT** install the door. Contact your dealer or distributor for recommendations.

### 2

### INSPECT ROUGH OPENING (R.O.)

Weatherproofing of the rough opening, along with the flashing and proper integration of the fenestration product with the water-resistive barrier, is the responsibility of the installer. JELD-WEN recommends strict adherence to the current version of ASTM E2112.

### CAUTION

The use of a sill pan and other barriers will decrease the rough opening height clearance. Adjust the opening dimensions accordingly.

#### Rough Opening Requirements

- Verify the width and height of the rough opening is a minimum of 3/4" larger than the door width and height.
- Verify the rough opening is square. The (A) and (B) measurements should be the same. Suggested deviation from square is no more than 1/4".
- Verify the rough opening is level and plumb (C, D and E). Suggested deviation is no more than 1/4".
- The rough opening sill should not be crowned or sagged (D), but rather level or sloped (positive slope) to the exterior.
- The exterior face of the rough opening should be in a single plane (E) with less than 1/8" twist from corner to corner.
- Minimum double studs (king and jack/trimmer) should be used to support the header at all rough openings.

#### Verify Square, Level and Plumb

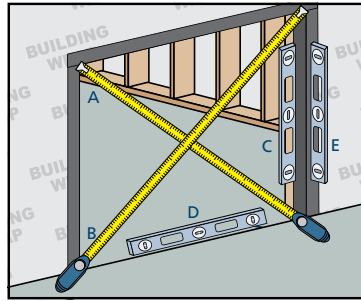

#### For Retrofit Installations

Verify the rough opening framing is structurally sound. Contact your local waste management entities for proper disposal or recycling of products being removed.

This installation guide only addresses masonry/block wall, sheathed wall, open-stud construction and exterior foam insulation. For exterior foam insulation construction, please reference the latest version of FMA/AAMA/WDMA 500 for additional install and framing details. If installing into an opening other than what is identified, consult a building professional.

#### Masonry/Block Wall Construction

This installation assumes that a framework of studs (often called a buck) has already been properly fastened in a weatherproof manner to the concrete/masonry wall. The door will be mounted into the buck in a weatherproof manner.

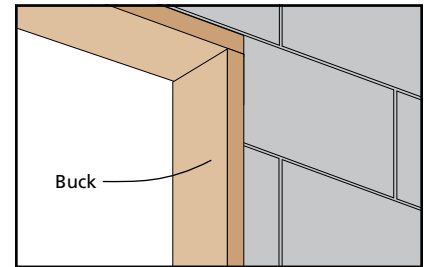

#### Fully Sheathed Wall Construction

Sheathing is applied to the exterior of the wall framing. The door will be mounted flush against the sheathing or building wrap in a weatherproof manner.

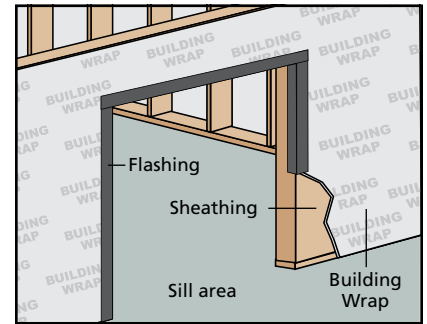

#### Open-Stud Construction

Sheathing is absent and building wrap is applied on top of the wall framing. The door will be mounted into the rough opening in a weatherproof manner.

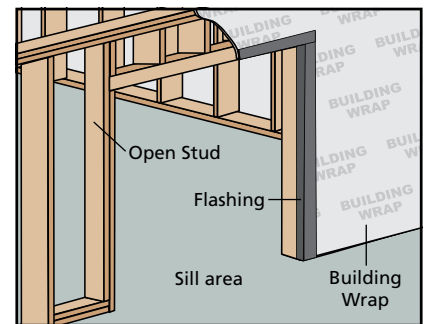

#### Exterior Foam Insulation Construction

Foam insulation is applied to the exterior of the wall framing. The door will be mounted to a structural support member on the same plane as the exterior foam insulation in a weatherproof manner (reference the latest version of FMA/AAMA/WDMA 500 for additional install and framing details).

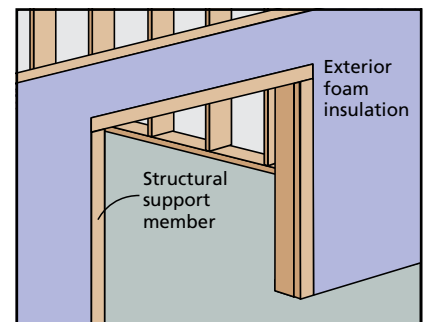

### 3

### INSTALL SILL PAN

#### Landings

These instructions cover two sill conditions: the **step-down landing** and the **continuous slab landing**. The installation methods vary slightly between landing types.

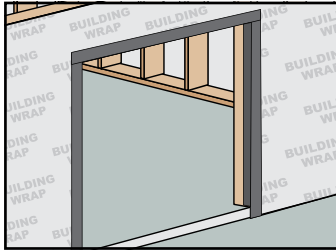

**Step-Down Landing**

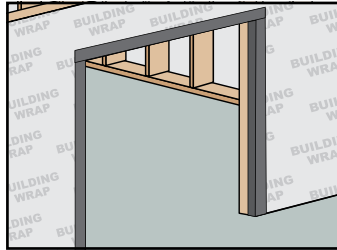

**Continuous Slab Landing**

#### Prepare Sill

1. A pan flashing system (as defined in **ASTM E2112**) is **required** at the sill prior to window/door installation. Always allow water to drain out of the pan and onto the building wrap, drainage plane or to the exterior. **NOTE:** Sill pans for step-down landings will have a folded-down edge in the front to accept the step-down landing.

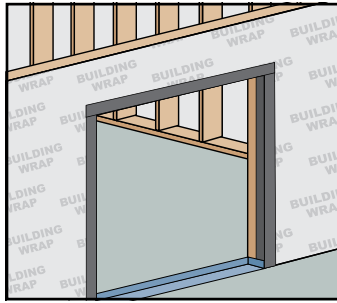

2. Apply a continuous bead of sealant to the interior upturned leg and end dams of the sill pan (if using a rigid sill pan).

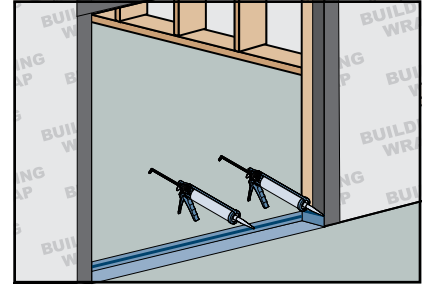

**NOTE:** For doors with an **ADA sill**, liquid applied membrane or threshold tape can be applied to the rough threshold/sill prior to the installation of the door. Dry fit the door frame to define flashing locations.

#### Shim the Sill

See **Product Installation Tolerance Table** for tolerances

1. Unless installing into a sill pan with a positive sloped draining system, shims should be aligned as defined by the label on the door or as stated below:
  - Shims (1/4" maximum) in height.
  - Place one shim 2" from each side of the rough opening.
  - Shims should be no more than 8" on-center.
  - There should always be a drainage path to the exterior out of the sill pan.
  - Shims can be held in place with sealant.
  - Increased shim height may be needed or may interfere with bar/grill alignment of adjacent windows/doors.

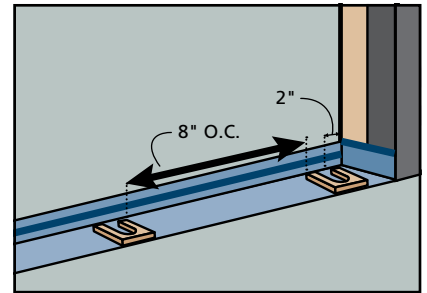

**NOTE:** The steps above exclude doors with an **ADA sill**.

### 4

### INSTALL DOOR

#### 2" Exterior Door Jamb Extension Kit Only

##### Kit Includes:

- 2-Side jamb pieces
- 1-Head jamb piece
- 1-Sill extender

##### Needed tools:

- Pencil
- Measuring tape
- Saw
- Drill with bits
- Caulking gun
- Putty knife
- Clamps
- Pry bar

##### Needed Materials:

- # 8 x 2 1/2" truss head screws
- Sealant (paintable)
- Wood putty or spackle
- Finishing supplies

1. Carefully remove (pry off/unscrew) the installed brickmould trim if present.
2. To install the sill extender, tilt the extender up at a 45° angle to hook onto the nose of the sill and align the edges of the sill extender flush to the sill. Push the front down and step on the sill extender to snap into place.

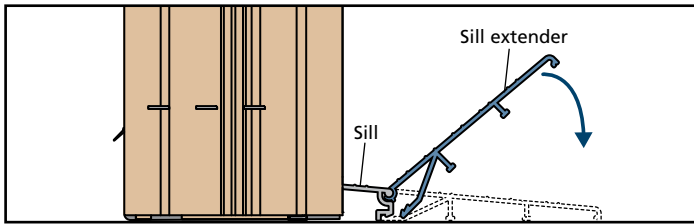

3. Each end of the jamb extender is handed and is beveled on one end to fit the profile of the sloped sill. Place the extender against the side jamb of the door frame with the beveled edge on the sill.

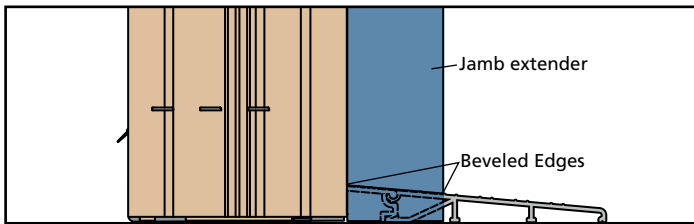

4. Mark the jamb extenders flush with the top/outside edge of the side jamb as shown and cut to length. Pre-drill a 1/8" hole (horizontally centered of the jamb extender) 2" - 4" from each end and 3 more evenly spaced between the initial pre-drilled edges.

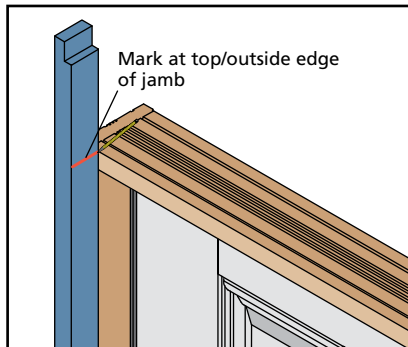

5. Run a 1/4" bead of sealant along the bottom of the extender where the beveled edge contacts the sill and up the length of the extender that will contact the side jamb.

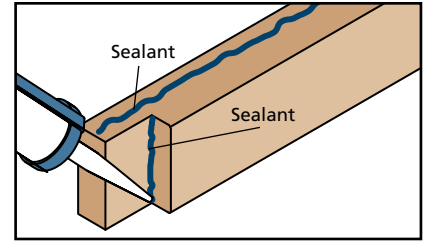

6. Secure the extenders to the side jamb (clamp in place if necessary) with 2 1/2" flat-head screws through the pre-drilled holes. Set the screw heads 1/4" below the surface.

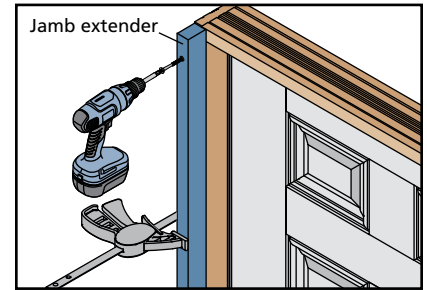

7. Measure the distance between the two jamb extenders and cut the head extender to length. Pre-drill a 1/8" hole 2" - 4" from both edges and one in the center. Apply a 1/4" bead of sealant the length of the extender on the surface that will contact the head jamb. Secure with 2 1/2" flat-head screws through the pre-drilled holes. Set the screw heads 1/4" below the surface.

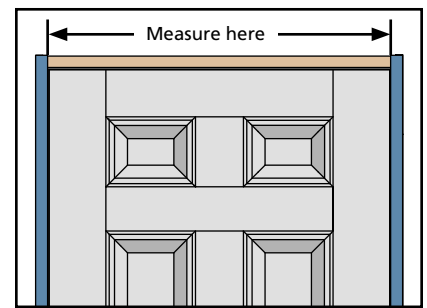

8. Fill all holes with wood putty or spackle. Sealant can be applied and smoothed to the joint between the extenders and the existing door frame/sill for a seamless appearance.
9. Finish all exposed wood parts with high-end finishing products.

### 4

### INSTALL DOOR (CONTINUED)

#### ⚠️ WARNING

To avoid injury, use at least 2-people to install. Adequately support the door until fully installed.

#### Prepare Door

1. Ensure any duplex nails, removable plastic plugs or shipping straps are removed prior to installation.

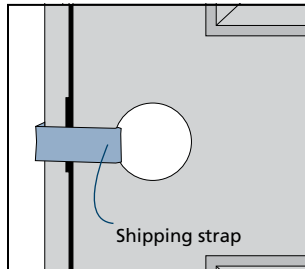

2. If interior trim is applied, apply a continuous bead of silicone sealant where the exterior trim meets the door frame as shown. Tool into a fillet shape.

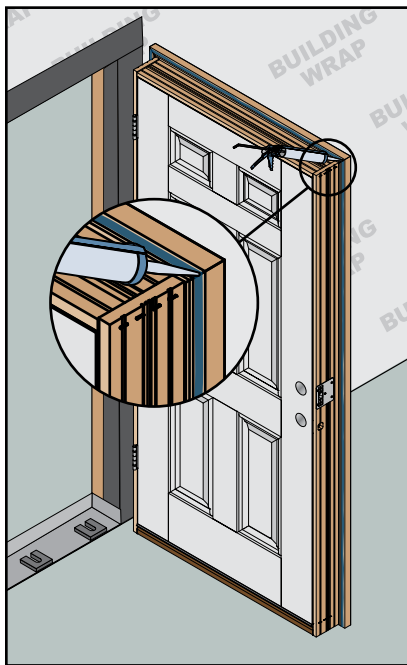

#### ⚠️ WARNING

If installing fasteners through fiberglass components, we recommend pre-drilling holes to keep the fiberglass from splitting.

#### Install Door

**NOTE:** This section covers single door and doors with a transom or a sidelite(s) already installed by the factory.

1. Adequately support the slab to keep it from swinging open during installation.
2. For units with brickmould trim, apply a 3/8" bead of sealant to the back of the trim where it will contact the structure. From the outside, tilt the entire pre-hung door into the center of the opening. Make sure the sill contacts the sealant on the sill pan back dam (upturned leg on the interior) if using a rigid sill.

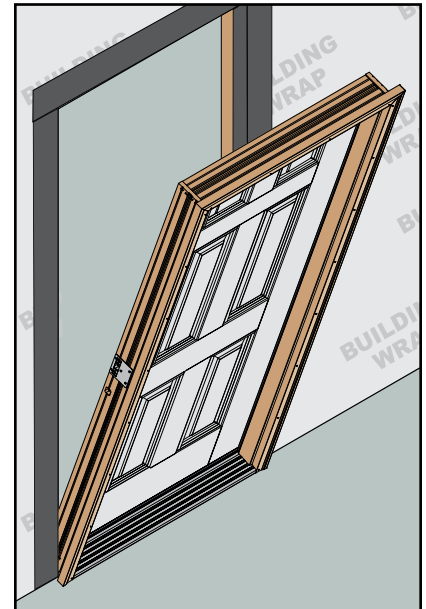

3. From the inside, shim the jambs as follows: one shim on each end of the sill (between jamb and sill, not under sill). Shim at each hinge location and the strike plate. Units with sidelites, between the sidelite and wall in at least 3 places until the door is square in the opening.

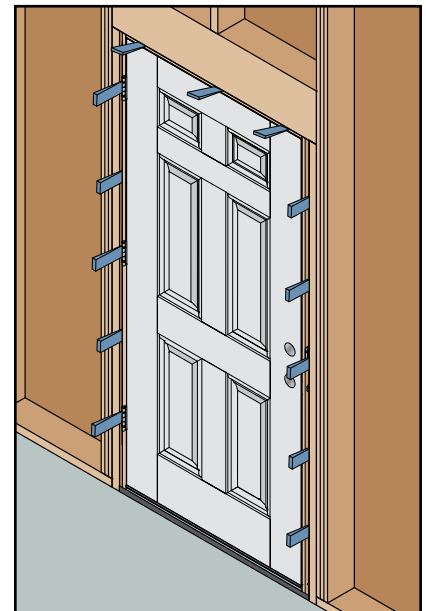

### 4

### INSTALL DOOR (CONTINUED)

#### Temporarily fasten the door as follows:

- For doors without a sidelite(s), secure the hinge jamb by placing one 10d casing nail (or one #8 x 2 1/2" flat-head screw) horizontally centered in the hinge jamb 20" from the top and bottom (or just above the lower hinge) of the door. **DO NOT** set nails/screws. For appearance reasons, fasteners can be driven behind (but not through) the weatherstrip if desired. For doors with sidelite(s), secure in a similar manner through the frame and into the wall.

#### Inswing Door

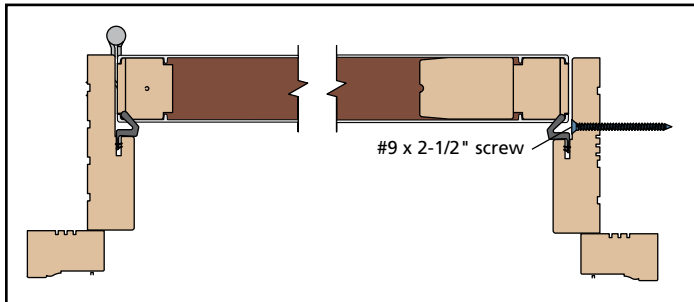

#### Outswing Door

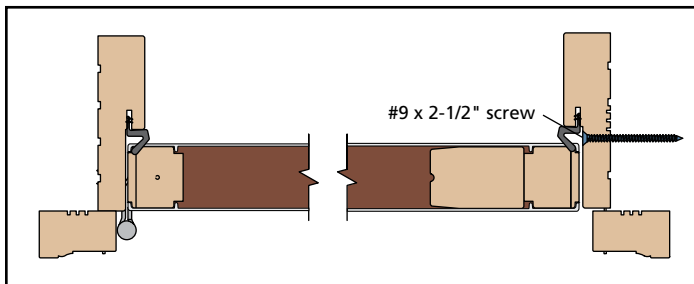

- Temporarily fasten the latch jamb by placing one 10d casing nail (or one #8 x 2 1/2" flat-head screw) horizontally centered in the latch jamb 16" from the top and bottom of the door. **DO NOT** set nails/screws. **NOTE:** Excludes doors with sidelites.
- Ensure the door opens freely and that the space between the door and the jamb is even on all sides. If necessary, adjust by loosening or removing the strike jamb fasteners until there is even contact between the slab and weatherstrip.
- Verify the door unit is square, level, plumb and without twist (see Product Installation Tolerance Table), then securely fasten the hinge jamb by setting the two nails or screws installed earlier. Add an additional nail or screw centered between the first two and one 4" from each corner.

#### Product Installation Tolerance Table

Products must be installed in a manner that **Does Not** exceed the tolerance below

|               |          |
|---------------|----------|
| <b>Plumb</b>  | +/- 1/8" |
| <b>Level</b>  | +/- 1/8" |
| <b>Twist</b>  | +/- 1/8" |
| <b>Square</b> | +/- 1/4" |

#### Finish Installation

- Re-check for smooth door operation and even spacing between the door and jamb. Secure the strike jamb evenly between the first two already in place with two more 10d casing nails (or #8 x 2 1/2" flat-head screws) behind the weatherstrip.

#### **NOTE: Steps 2 and 3 apply only to units with hinge jamb(s) against the rough opening.**

- Install two provided #9 x 2 1/2" wood screws in the top hinge through the two holes closest to the weatherstrip, driving them through the hinge jamb and into the studs. Remove the screws already in the hinges to insert these longer screws.

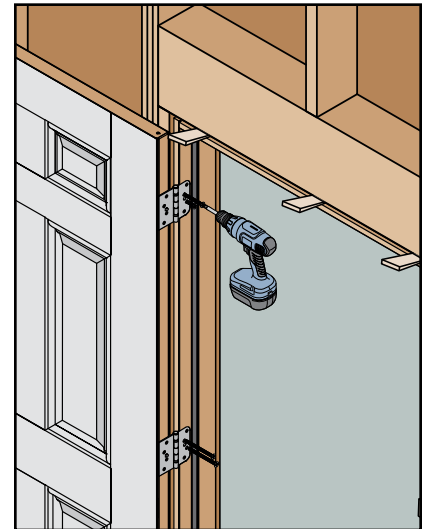

- Test for ideal contact between the door sweep and the threshold. Adjust the threshold with a screwdriver, if needed. Turn the screw clockwise to reduce tension and counterclockwise to increase tension.

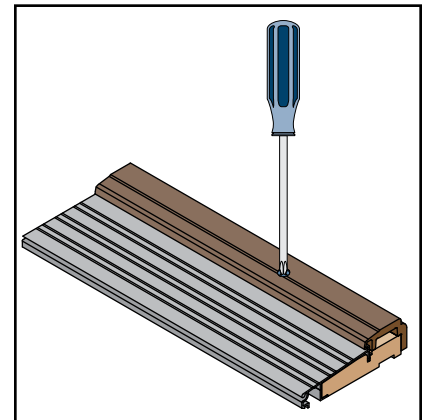

- At the sill, pull the weatherstrip up slightly and apply a bead of sealant (behind the weatherstrip) at the intersection of the sill to jambs and trim (apply to both ends of the sill). The included foam wedges are used to complete the weatherstrip seal at each bottom corner between the jamb and operating slab(s) when closed. Position the thick edge behind the weatherstrip, remove the backing paper and adhere to the jamb as shown.

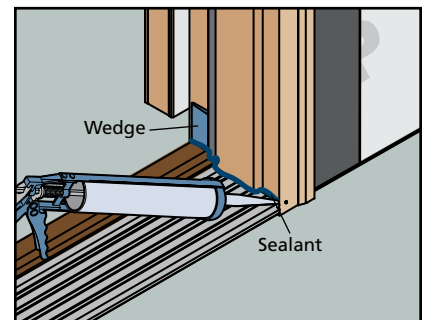



### 4

#### INSTALL DOOR (CONTINUED)

5. Ensure sealant on back dam of the sill pan fully seals to the inside face of the sill. Apply more sealant as necessary.
6. On the exterior of step-down landings, install support trim underneath the sill where it extends past the landing. Position the toe-kick trim snug against the bottom of the sill toe/nose. **NOTE: DO NOT** apply sealant to the backside of the trim as water must be able to exit the sill pan.

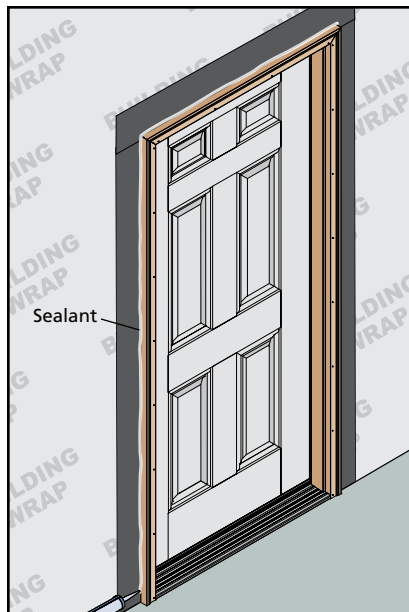

#### Finishing Sidelite or Transom Installations

1. If installing a door with a sidelite(s), shim the head on both sides of the joint where the sidelite joins the door jamb. Fasten next to the shims and then remove shims.
2. Shim the head of units with sidelite(s) at the center of each slab/sidelite. Fasten next to the shims and then remove shims. Similarly fasten a transom every 16".

### 5

#### INSTALL DRIP CAP

A drip cap is not provided with this door unit; however, the use of a drip cap is strongly recommended and may be required by local code.

1. Cut a piece of drip cap the length of the header brickmould plus 1/4" to allow for 1/8" overlap past the ends of the door frame or exterior trim.

2. Apply a 1/4" bead of sealant to the top of the door frame or exterior trim along the front and side edges.
3. Nail the drip cap into place and apply sealant to the edges on the side.

### 6

#### CREATE "INTERIOR" AIR SEAL

##### Continuous Air Seal

**NOTE:** Shims may need to be cut back, so the interior air seal is "continuous" between the door frame and the rough opening.

Create a **required** continuous air seal on the interior by integrating the rough opening and the door frame with low-expansion polyurethane foam or backer rod and sealant. **NOTE:** If foam is used, a 1/2" - 1" depth is prescribed. Backer rod can be used to control the depth.

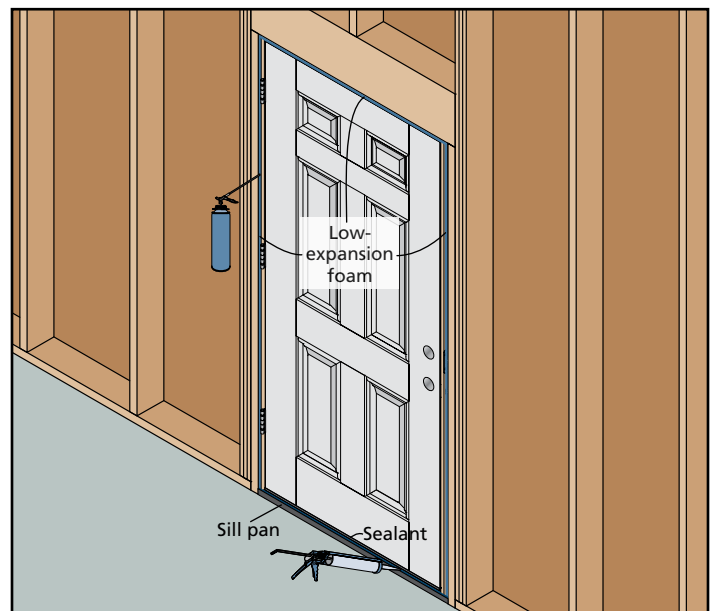

### 7

#### REMOVE PROTECTIVE FILM

## NOTICE

If applicable, remove any protective film immediately from all surfaces of the frame/panel and within six months from any glass.

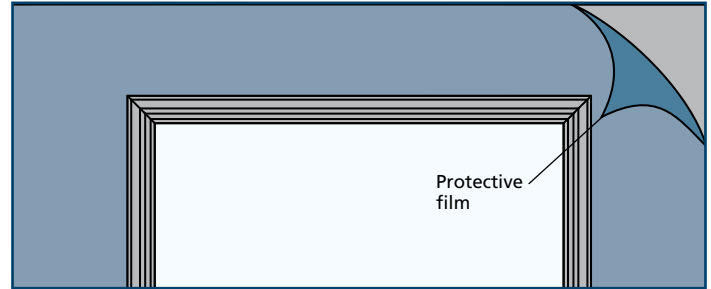

### 8

#### AFTER INSTALLATION

**Weatherproofing of the rough opening, along with the flashing and proper integration of the fenestration product with the water-resistive barrier, is the responsibility of the installer. JELD-WEN recommends strict adherence to the current version of ASTM E2112.**

- Leave an expansion/contraction gap of approximately 3/8" between the door frame and the final exterior wall surface (siding, stucco, etc.).
- If sealant is applied above the drip cap, ensure the sealant bead is discontinuous to allow for drainage.
- Protect recently installed units from damage from plaster, paint, etc.
- Fill any nail/screw holes and sand smooth.
- Finish all six sides of the door slab as well as the frame.
- Install lock set hardware per supplied instructions.



For additional fire door information, please scan the QR code or reference Installation Instructions for Fire-Rated Doors (JI-90081) at [www.jeld-wen.com](http://www.jeld-wen.com).



For care and maintenance information, please scan the QR code or reference Care and Maintenance for Interior and Exterior Doors (JCM005) at [www.jeld-wen.com](http://www.jeld-wen.com).



For finishing and refinishing information, please scan the QR code or reference Finishing and Refinishing Instructions for Interior and Exterior Door Slabs and Systems (JCM004) at [www.jeld-wen.com](http://www.jeld-wen.com).



For door protection information, please scan the QR code or reference Appropriate Protection for Exterior Doors (JGI030) at [www.jeld-wen.com](http://www.jeld-wen.com).

Please visit [jeld-wen.com](http://jeld-wen.com) for warranty and care and maintenance information.

Thank you for choosing

# JELD-WEN